











## Especificações (Luminárias da série)



	<b>Isolamento elétrico</b>	CCI
	<b>Tensão (V)</b>	220-240V
<b>Hz</b>	<b>Frequência (Hz)</b>	50-60Hz
	<b>Fator de Potência (Cos fi)</b>	>0,9

	<b>Índice de estanqueidade IP</b>	IP65
	<b>IK Proteção contra impactos</b>	IK06
	<b>Cor do corpo</b>	Branco
	<b>Material Difusor</b>	VT-T
	<b>Corpo</b>	Al

<b>K</b>	<b>Temperatura de cor</b>	3000K
	<b>CRI Índice de repr. cromática</b>	80cromatica
	<b>Angulo de abertura</b>	100°



	<b>Dimensão</b>	287x243x37mm
	<b>Posição de montagem</b>	Superfície

	<b>Fluxo (lm)</b>	6203lm
---	-------------------	--------

	<b>Vida</b>	(L70B50>)25.000h
	<b>Vida</b>	(L70B50>)25.000h

**Referências**



	W	$\phi_{LUM}$	K		
<b>504713</b>	70W	6203lm	3000K	Branco	287x243x37mm

**Dimensões**

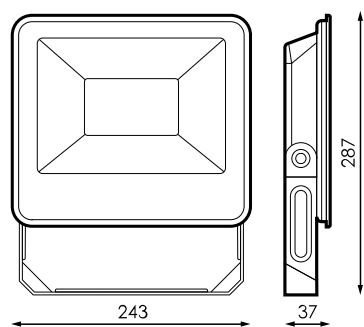

**Fotometria**



**Informacje**



Hasta fin de existencias