











## Especificaciones (Luminarias de Serie)

	<b>Aislamiento eléctrico</b>	CI
	<b>Tensión (V)</b>	230V
<b>Hz</b>	<b>Frecuencia (Hz)</b>	50-60Hz
	<b>Factor de potencia (Cos fi)</b>	>0,9

	<b>IP Índice de estanqueidad</b>	IP65
	<b>Color cuerpo</b>	7045
	<b>Difusor</b>	VT-O
	<b>Cuerpo</b>	AL

<b>K</b>	<b>Temperatura de color</b>	5.000K
	<b>CRI Índice de repr. cromática</b>	>80
	<b>Ángulo de apertura</b>	110°



	<b>Dimensiones</b>	287x243x37mm
---	--------------------	--------------

	<b>Flujo luminoso (lm)</b>	6.318lm
---	----------------------------	---------

	<b>Vida útil</b>	(L70B50>) 25.000h
---	------------------	-------------------

**Referencias**



	W	$\phi_{LUM}$	K		
<b>504720</b>	70W	6.318lm	5.000K	RAL7045	287x243x37mm

**Dimensiones**

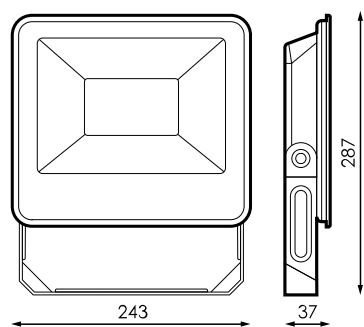

**Fotometría**

