













## Spécifications (Luminaires de la série)



	<b>Isolation électrique</b>	CCI
	<b>Tension D` Alimentation (V)</b>	220-240V
<b>Hz</b>	<b>Fréquence (Hz)</b>	50-60Hz
	<b>Facteur de puissance (Cos fi)</b>	>0,9

	<b>Indice d'étanchéité IP</b>	IP65
	<b>IK Protection contre des impacts</b>	IK06
	<b>Couleur du corps</b>	RAL7045
	<b>Matériau du diffuseur</b>	VT-T
	<b>Corps</b>	Al

<b>K</b>	<b>Température de couleur</b>	5000K
	<b>CRI Indice de rendu des couleurs</b>	>80
	<b>Angle d'ouverture</b>	100°



	<b>Dimensions</b>	287x243x37mm
	<b>Position de montage</b>	Superficie

	<b>Flux (lm)</b>	6318lm
---	------------------	--------

	<b>Heures de vie</b>	(L70B50>)25.000h
	<b>Heures de vie</b>	(L70B50>)25.000h

**Les références**



	W	$\phi_{LUM}$	K		
<b>504720</b>	70W	6318lm	5000K	Gris foncé	287x243x37mm

**Dimensions**

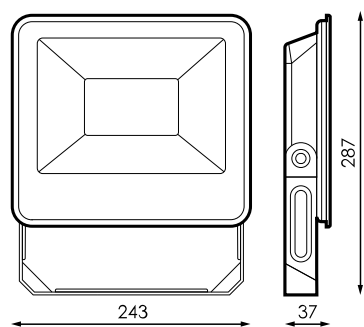

**Photométrie**



**Info**



Hasta fin de existencias