











Spécifications (Luminaires de la série)

	Isolation électrique	CI
	Tension D` Alimentation (V)	230V
Hz	Fréquence (Hz)	50-60Hz
	Facteur de puissance (Cos fi)	>0,9

	Indice d'étanchéité IP	IP65
	Couleur du corps	7045
	Matériau du diffuseur	VT-O
	Corps	AL

K	Température de couleur	3.000K
	CRI Indice de rendu des couleurs	>80
	Angle d'ouverture	110°



	Dimensions	313x243x37mm
---	-------------------	--------------

	Flux (lm)	8.711lm
---	------------------	---------

	Heures de vie	(L70B50>) 25.000h
---	----------------------	-------------------

Les références



	W	ϕ_{LUM}	K		
504737	100W	8.711lm	3.000K	Gris foncé	313x243x37mm

Dimensions

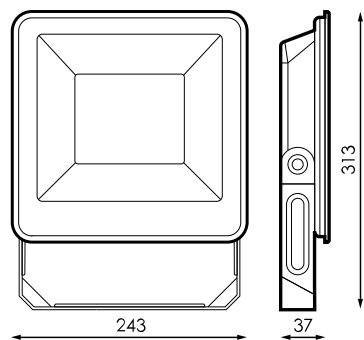

Photométrie

