



















Spécifications (Luminaires de la série)

	Isolation électrique	CI
	Tension D` Alimentation (V)	220-240V
Hz	Fréquence (Hz)	Hz
	Indice d'étanchéité IP	IP65
	IK Protection contre des impacts	IK06
	Couleur du corps	7045
	Matériau du diffuseur	VT-T
	Corps	AL
K	Température de couleur	5.000K
	CRI Indice de rendu des couleurs	≥80
	Angle d'ouverture	110°
	Dimensions	313x243x37mm
	Position de montage	Superficie
	Température de service	-30 +50
	Flux (lm)	8839lm
	Heures de vie	25.000h

Les références



	W	ϕ_{LUM}	K		
504744	100W	8839lm	5.000K	Gris foncé	313x243x37mm

Dimensions

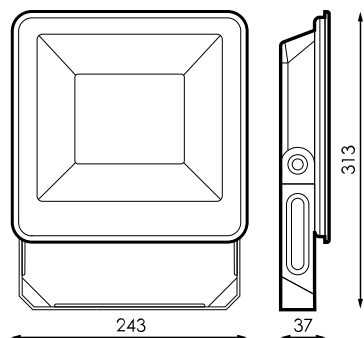

Photométrie

