















Spécifications (Luminaires de la série)

	Isolation électrique	CI
	Tension D` Alimentation (V)	230V
Hz	Fréquence (Hz)	50-60Hz
ϕ	Facteur de puissance (Cos fi)	>0,9
	Indice d'étanchéité IP	IP65
	Couleur du corps	7045
	Matériau du diffuseur	VT-O
	Corps	AL
K	Température de couleur	5.000K
	CRI Indice de rendu des couleurs	>80
	Angle d'ouverture	110°
	Dimensions	186x135x56mm
ϕ_{LUM}	Flux (lm)	2.743lm
	Heures de vie	(L70B50>) 25.000h

Les références



	W	ϕ_{LUM}	K		
504775	30W	2.743lm	5.000K	Gris foncé	186x135x56mm

Dimensions

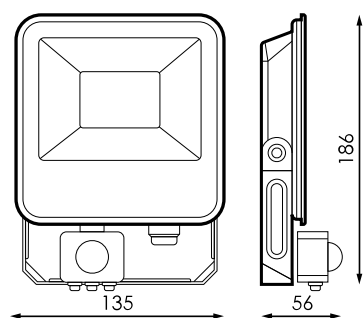

Photométrie

