





















Especificações (Luminárias da série)

	Isolamento elétrico	CCI
	Tensão (V)	220-240V
Hz	Frequência (Hz)	50-60Hz
	Fator de Potência (Cos fi)	>0,9
	Índice de estanqueidade IP	IP65
	IK Proteção contra impactos	IK06
	Cor do corpo	7045
	Material Difusor	VT-T
	Corpo	Al
K	Temperatura de cor	5000K
	CRI Índice de repr. cromática	80cromatica
	Angulo de abertura	100°
	Dimensão	240x180x56mm
	Posição de montagem	Superfície
	Fluxo (lm)	4516lm
	Vida	(L70B50>)25.000h
	Vida	(L70B50>)25.000h

Referências



	W	ϕ_{LUM}	K		
504782	50W	4516lm	5000K	Cinza escuro	240x180x56mm

Dimensões

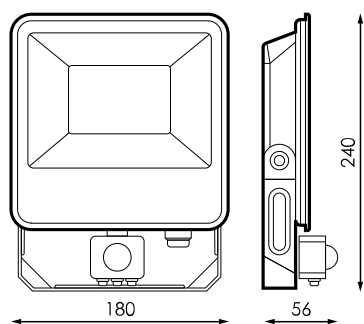

Fotometria



Informacje



Hasta fin de existencias