

**MADE IN SPAIN**  
Desing by PRILUX



## Aplicaciones



Carreteras



Autovías

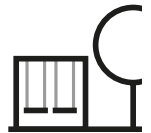

Parques

## Certificaciones



Zonas Residenciales

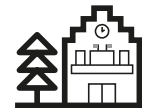

Zonas Peatonales



Carril bici





















Parkings



Perímetros

## Especificaciones

	<b>Tensión (V)</b>	220-240
Hz	<b>Frecuencia (Hz)</b>	50-60
	<b>Intensidad (A)</b>	1.000mA
$\phi$	<b>Factor de potencia (Cos fi)</b>	0,98cosf
	<b>Número de leds</b>	32
	<b>Regulación</b>	5N,DN/LM
	<b>IP Índice de estanqueidad</b>	66
	<b>IK Protección contra impactos</b>	9
	<b>Color cuerpo</b>	9007
	<b>Difusor</b>	VT-T
	<b>Cuerpo</b>	AL iap
K	<b>Temperatura de color</b>	4000k
	<b>CRI Índice de repr. cromática</b>	>70
	<b>Óptica</b>	VA



	<b>Dimensiones</b>	478x468x107
	<b>Peso</b>	5.950Kg
	<b>Resistencia al Viento</b>	0,072m2
	<b>Montaje</b>	Montaje en Brazo, Montaje e Báculo
	<b>Inclinación</b>	-25° / +25°
	<b>Temp. de funcionamiento</b>	-30 +50
$\phi_{LUM}$	<b>Flujo luminoso (lm)</b>	12.529lm
$\eta$	<b>Rendimiento</b>	0,85%
	<b>Aislamiento eléctrico</b>	I
	<b>L70 B10 &gt;(500&lt;math&gt;\leq 1.000mA&lt;/math&gt;)</b>	L90 B10 >200.000h

Prilux garantiza una tolerancia  $\pm 10\%$  en las medidas de flujo luminoso.

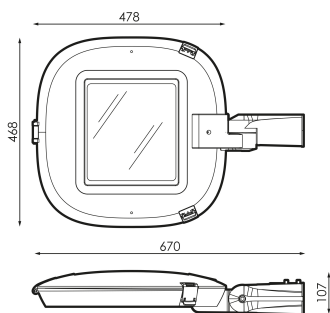
## Dimensiones



## Referencias

	W	W		$\phi$	$\phi_{LED}$	$\phi_{LUM}$	$\phi/W$	$\eta$	
<b>508179</b>	96W	100,9W	1.000mA	15.907lm	14.740lm	12.529lm	124W	0,85%	32

## Fotometría

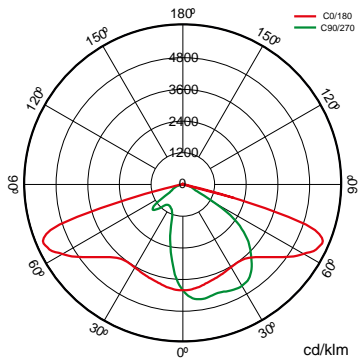

## Bajo Pedido

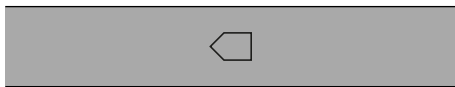

Clase II

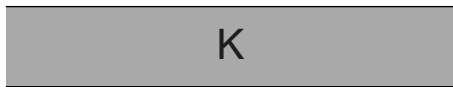



3000K-5000K



Protección Control de temperatura

## Paquetes lumínicos



			PCA	727	730	750	827	830	840
W			$\phi_{LUM}$ $\phi/W$	$\phi_{LUM}$ $\phi/W$	$\phi_{LUM}$ $\phi/W$	$\phi_{LUM}$ $\phi/W$	$\phi_{LUM}$ $\phi/W$	$\phi_{LUM}$ $\phi/W$	$\phi_{LUM}$ $\phi/W$
<b>100,9W</b>	32	1.000mA		11.213lm 111lm/W	11.918lm 118lm/W	12.529lm 124lm/W	10.302lm 102lm/W	10.302lm 102lm/W	10.858lm 108lm/W

## Montaje



1. Montaje en Brazo
2. Montaje en Báculo



## Tecnologías



### WAS



La tecnología WAS (White Adaptative System) proporciona a las luminarias PRILUX la capacidad de cambiar tanto la cantidad de luz que proporcionan como la temperatura de color correlacionada, CCT.



### Overstorm



La tecnología OVERSTORM está pensada para aquellas luminarias que normalmente se enfrentan a entornos eléctricamente agresivos. Dota al producto de tres esferas de protección: En la esfera exterior un protector contra sobretensiones independiente suprime las eventuales subidas de tensión, la esfera intermedia los drivers están preparados para soportar picos de tensión de hasta 6 kV y 10kV. En la esfera nuclear la protección en el módulo LED se proporciona tanto en su entrada, para las pequeñas sobretensiones que no han sido filtradas por las esferas externas.



### SystemShield



La tecnología SYSTEMSHIELD está pensada para garantizar las horas de vida útil de luminarias instaladas en entornos en los que superar la temperatura máxima de operación es posible e incluso probable. Mediante sondas térmicas la luminaria conoce en todo momento su temperatura de funcionamiento.



### CMR



CMR (CORA MANAGER READY) identifica a las luminarias de prilux compatibles con el sistema CORA MANAGER que dota a las luminarias de control regulación y programación.

## Normas



Prilux garantiza una tolerancia  $\pm 10\%$  en las medidas de flujo lumínico.

## Info



Para obtener más información de las diferentes soluciones compatibles con esta luminaria consulte en los siguientes códigos BIDI o en la web [www.grupoprilux.com](http://www.grupoprilux.com)