

MADE IN SPAIN
Design by PRILUX



Applications



Facades

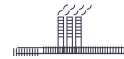

Industrial



Car parks

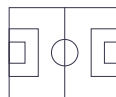

Sports grounds



Monuments

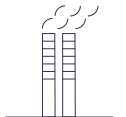

















Industrial Zones

Certifications



Specifications (Series luminaires)

	Voltage (V)	220-240V
Hz	Frecuency (Hz)	50-60Hz
	Current (A)	700mA
ϕ	Power factor (Cos fi)	0.97
	LED number	108
	Dimming	No
	IP Tightness index	IP66
	IK Impact resistance	IK09
	Body color	9007
	Body	AL iap
K	Colour temperature	4000K
	CRI Colour rendering index	70cromatica
	Optical	S090I2P



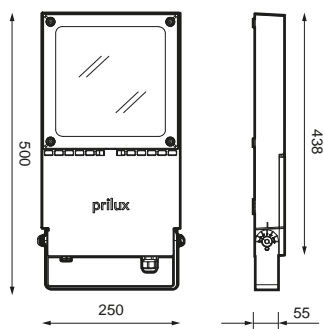

	Measures	500x250x55mm
	Weight	5.75Kg
	Wind Resistance	0,11m2
	Operating temperature	50°C
	Surges protection	No
ϕ_{LUM}	Flux (lm)	11730lm
	Electrical isolation	CCI
	Lifetime	L70B10>100.000h

Prilux guarantees a $\pm 10\%$ tolerance in light flux measurements.

Dimensions



References

	W_{LED}	W		ϕ	ϕ_{LED}	ϕ_{LUM}	ϕ/W			
519892	73W	79,1W	700mA	13635lm	13483lm	11730lm	148lm/W	108	S090I2P	No

Photometry

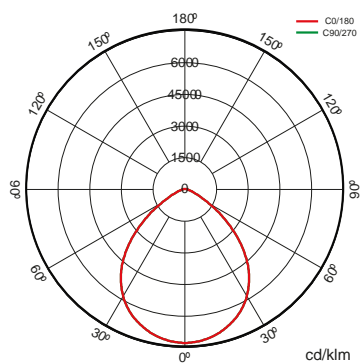

On request

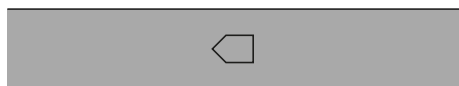

Class II



Double Level with Line of Command



Available RAL colors (Consult)

5N

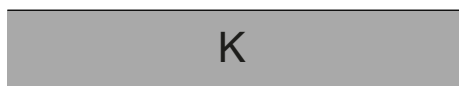

>70 2.700K

>70 5.000K

>80 3.000K

>80 4.000K

>80 4.000K

>70 2.700K



S025I2P



S055I2P

VA11I2P

VA12I2P

Light packages



			PCA	722	727	730	827	830	840
W			ϕ_{LUM} ϕ/W	ϕ_{LUM} ϕ/W	ϕ_{LUM} ϕ/W	ϕ_{LUM} ϕ/W	ϕ_{LUM} ϕ/W	ϕ_{LUM} ϕ/W	ϕ_{LUM} ϕ/W
79,1W	108	700mA					9.926lm 126lm/W	10.377lm 131lm/W	11.279lm 143lm/W

Accessories



515788

ACCESSORY
PARALUMEN
NANTES RAL9005T

Solutions

S



**Cora
Manager**

description



Lighting management in the electrical panel that allows group control of the luminaires connected to the control center via the power line (CMR) without additional wiring

Info



For more information on the different solutions compatible with this luminaire, consult the following BIDI codes or on the web www.prilux.es