

MADE IN SPAIN
Design by PRILUX



Aplicaciones



Fachadas

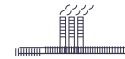

Perímetros



Parkings

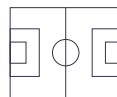

Recintos deportivos



Monumentos

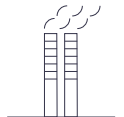

Zonas Industriales

Certificaciones



Especificaciones (Luminarias de Serie)



	Tensión (V)	220-240V
Hz	Frecuencia (Hz)	50-60Hz
	Intensidad (A)	1.000mA
ϕ	Factor de potencia (Cos fi)	0.98
	Número de leds	108
	Regulación	Si
	IP Índice de estanqueidad	IP66
K	Temperatura de color	4000
	CRI Índice de repr. cromática	70cromatica
	Óptica	S090I2P

	Dimensiones	500x250x55mm
	Peso	5.75Kg
	Resistencia al Viento	0,11m2
	Temp. de funcionamiento	-30~+50°C
	Protección sobretensiones	No
ϕ_{LUM}	Flujo luminoso (lm)	15.770lm
	Aislamiento eléctrico	CCI
	Vida útil	100.000h



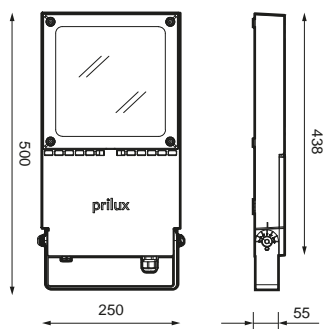

Prilux garantiza una tolerancia $\pm 10\%$ en las medidas de flujo luminoso.

Dimensiones



Referencias



	W_{LED}	W		ϕ_{LUM}			
519915	110W	118,4W	1000mA	15.770lm	108	S090I2P	Si

Fotometría

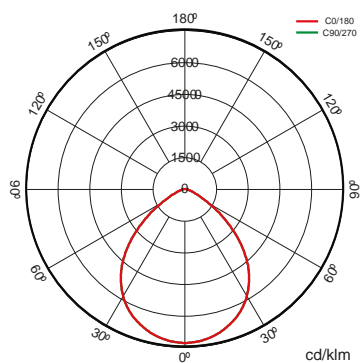

Accesorios



515788

ACCESORIO
PARALUMEN
NANTES RAL9005T



593861

ACCESORIO ZENIT
RAL9007T



609319

ACCESORIO ROAD
RAL9007T