















Specifications (Series luminaires)



| | | |
|---|-----------------------------------|-------------------|
|  | Electrical isolation | CI |
|  | Voltage (V) | 230V |
| Hz | Frecuency (Hz) | 50-60Hz |
|  | Power factor (Cos fi) | >0,9 |
|  | IP Tightness index | IP65 |
|  | Body color | White |
|  | Diffuser Material | VT-O |
|  | Body | AL |
| K | Colour temperature | 5.000K |
|  | CRI Colour rendering index | >80 |
|  | Opening angle | 110° |
|  | Measures | 186x135x30mm |
|  | Flux (lm) | 2.743lm |
|  | Lifetime | (L70B50>) 25.000h |

References



|  | W | ϕ_{LUM} | K |  |  |
|---|-----|--------------|--------|---|---|
| 522533 | 30W | 2.743lm | 5.000K | White | 186x135x30mm |

Dimensions

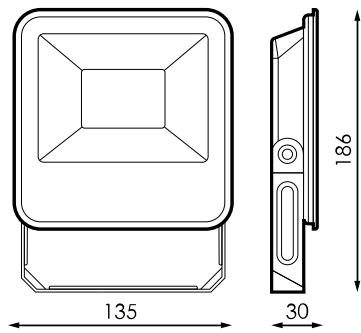

Photometry

