















Especificaciones (Luminarias de Serie)

	Aislamiento eléctrico	CI
	Tensión (V)	230V
Hz	Frecuencia (Hz)	50-60Hz
	Factor de potencia (Cos fi)	>0,9
	IP Índice de estanqueidad	IP65
	Color cuerpo	Blanco
	Difusor	VT-O
	Cuerpo	AL
K	Temperatura de color	5.000K
	CRI Índice de repr. cromática	>80
	Ángulo de apertura	110°
	Dimensiones	240x180x30mm
	Flujo luminoso (lm)	4.516lm
	Vida útil	(L70B50>) 25.000h

Referencias



	W	ϕ_{LUM}	K		
522540	50W	4.516lm	5.000K	Blanco	240x180x30mm

Dimensiones

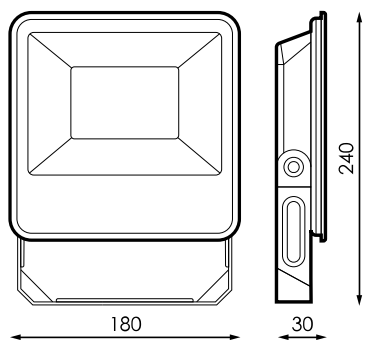

Fotometría

