

















### Spécifications (Luminaires de la série)



	<b>Isolation électrique</b>	CII
	<b>Tension D` Alimentation (V)</b>	180-250V
<b>Hz</b>	<b>Fréquence (Hz)</b>	50-60Hz
	<b>Atténuation</b>	1-10V
	<b>Indice d'étanchéité IP</b>	IP20
	<b>Couleur du corps</b>	Blanc
	<b>Matériau du diffuseur</b>	PC-O
	<b>Corps</b>	AL
<b>K</b>	<b>Température de couleur</b>	4.000K
	<b>CRI Indice de rendu des couleurs</b>	>80
	<b>Angle d'ouverture</b>	120°
	<b>Dimensions</b>	175x30mm
	<b>Position de montage</b>	Empotrar
	<b>Température de service</b>	-5°C~+35 °C
	<b>Flux (lm)</b>	1.551lm
	<b>Heures de vie</b>	(L70B50>) 50.000h

## Les références



	W	$\phi_{LUM}$	K					
<b>532150</b>	14W	1.551lm	4.000K	>80	Blanc	150-155	175x30mm	Oui

## Dimensions



## Photométrie

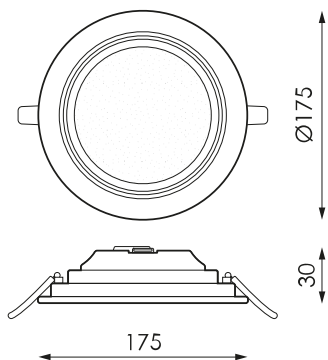



### Sur demande



Kit d'urgence 2h



Dali

### Accessoires



**387569**

ACCÉSSOIRE SAILLIE  
CIRCULAIRE KENTA  
U 14W BLANC



**532198**

DRIVER KENTA  
U 14W 1-10V



---

## Les technologies

---



---

### CELLTECH

---



La technologie CELLTECH est un système d'alimentation révolutionnaire pour luminaires qui permettent l'extraction et l'échange de pilotes qui facilite et simplifie l'installation et le montage des luminaires. Les drivers CELLTECH sont disponibles sans régulation et avec régulation 1-10V et C-TOUCH.

---



## Solutions

S



### Pack CTE

#### la description

Règlement pour l'apport de lumière naturelle pour se conformer aux exigences du CTE. Commande indépendante de deux lignes de luminaires DALI gradables avec capteur à installer dans un luminaire ou un boîtier de surface. Préconfiguré pour une utilisation facile.



### Pack SALLES

#### la description

Régulation par apport de lumière naturelle et présence autonome. Système de contrôle de l'éclairage pour répondre aux exigences du CTE et optimiser la consommation d'énergie en profitant de l'apport de lumière naturelle et d'un arrêt automatique en cas d'absence.



### Pack BLUETOOTH

#### la description

Dispositif qui permet le contrôle du luminaire DALI via n'importe quel terminal Bluetooth® via une APP gratuite qui nous offre le contrôle de la régulation du débit, de la couleur, de la configuration de la scène, du comportement lié aux horaires.

#### Info

Pour plus d'informations sur les différentes solutions compatibles avec ce luminaire, consultez les codes BIDI suivants ou sur le web [www.prilux.es](http://www.prilux.es)