











Especificaciones (Luminarias de Serie)

	Aislamiento eléctrico	CI
	Tensión (V)	230V
Hz	Frecuencia (Hz)	50-60Hz

	IP índice de estanqueidad	IP65
	Color cuerpo	Gris lona
	Difusor	PC-P
	Cuerpo	AL

K	Temperatura de color	3.000K
	CRI índice de repr. cromática	>80
	Ángulo de apertura	100°

	Dimensiones	158x134x28mm
---	--------------------	--------------



	Temp. de funcionamiento	-5°C~+35 °C
---	--------------------------------	-------------

	Flujo luminoso (lm)	1.438lm
---	----------------------------	---------

	Vida útil	(L70B50>) 25.000h
---	------------------	-------------------

Referencias



	W	ϕ_{LUM}	K		
534574	20W	1.438lm	3.000K	Gris lona	158x134x28mm

Dimensiones

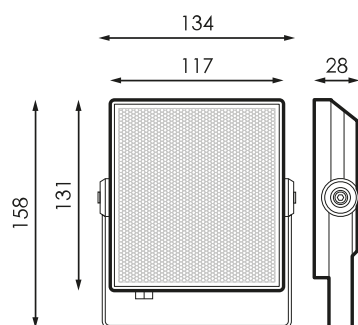

Fotometría



Info



Hasta fin de existencias