

















Spécifications (Luminaires de la série)

	Isolation électrique	CI
	Tension D` Alimentation (V)	230V
Hz	Fréquence (Hz)	50-60Hz
	Indice d'étanchéité IP	IP65
	Couleur du corps	Toile grise
	Matériau du diffuseur	PC-P
	Corps	AL
K	Température de couleur	3.000K
	CRI Indice de rendu des couleurs	>80
	Angle d'ouverture	100°
	Dimensions	158x134x28mm
	Température de service	-5°C~+35 °C
	Flux (lm)	1.438lm
	Heures de vie	(L70B50>) 25.000h

Les références



	W	ϕ_{LUM}	K		
534574	20W	1.438lm	3.000K	Toile grise	158x134x28mm

Dimensions

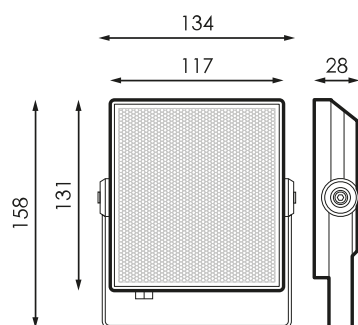

Photométrie



Info



Jusqu'à épuisement des stocks