

















Especificaciones (Luminarias de Serie)

	Aislamiento eléctrico	CI
	Tensión (V)	230V
Hz	Frecuencia (Hz)	50-60Hz
	IP índice de estanqueidad	IP65
	Color cuerpo	Gris lona
	Difusor	PC-P
	Cuerpo	AL
K	Temperatura de color	5.000K
	CRI índice de repr. cromática	>80
	Ángulo de apertura	100°
	Dimensiones	158x134x28mm
	Temp. de funcionamiento	-5°C~+35 °C
	Flujo luminoso (lm)	1.576lm
	Vida útil	(L70B50>) 25.000h

Referencias



	W	ϕ_{LUM}	K		
534581	20W	1.576lm	5.000K	Gris lona	158x134x28mm

Dimensiones

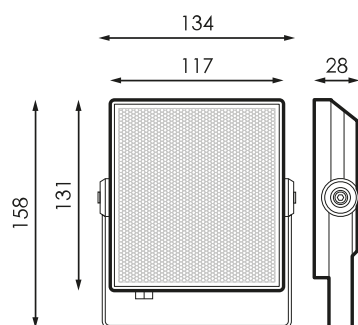

Fotometría



Info



Hasta fin de existencias