















Especificaciones (Luminarias de Serie)

	Aislamiento eléctrico	CI
	Tensión (V)	230V
Hz	Frecuencia (Hz)	50-60Hz
	IP Índice de estanqueidad	IP65
	Color cuerpo	Gris lona
	Difusor	PC-P
	Cuerpo	AL
K	Temperatura de color	3.000K
	CRI Índice de repr. cromática	>80
	Ángulo de apertura	100°
	Dimensiones	298x220x39mm
	Temp. de funcionamiento	-5°C~+35 °C
	Flujo luminoso (lm)	4.318lm
	Vida útil	(L70B50>) 25.000h

Referencias



	W	ϕ_{LUM}	K		
534611	50W	4.318lm	3.000K	Gris lona	298x220x39mm

Dimensiones

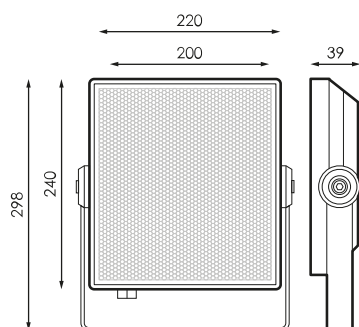

Fotometría

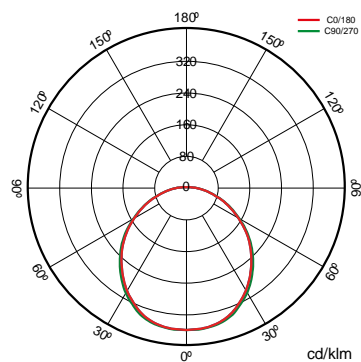

Info



Hasta fin de existencias