

















## Spécifications (Luminaires de la série)

|   |   |                   |
|---|---|-------------------|
|    | <b>Isolation électrique</b>             | CI                |
|    | <b>Tension D` Alimentation (V)</b>      | 230V              |
| <b>Hz</b>   | <b>Fréquence (Hz)</b>                   | 50-60Hz           |
|    | <b>Indice d'étanchéité IP</b>           | IP65              |
|    | <b>Couleur du corps</b>                 | Toile grise       |
|    | <b>Matériau du diffuseur</b>            | PC-P              |
|    | <b>Corps</b>                            | AL                |
| <b>K</b>  | <b>Température de couleur</b>           | 3.000K            |
|    | <b>CRI Indice de rendu des couleurs</b> | >80               |
|   | <b>Angle d'ouverture</b>                | 100°              |
|  | <b>Dimensions</b>                       | 298x220x39mm      |
|  | <b>Température de service</b>           | -5°C~+35 °C       |
|  | <b>Flux (lm)</b>                        | 4.318lm           |
|  | <b>Heures de vie</b>                    | (L70B50>) 25.000h |

## Les références

|  | W   | $\phi_{LUM}$ | K      |  |  |
|---|-----|--------------|--------|---|---|
| <b>534611</b>   | 50W | 4.318lm      | 3.000K | Toile grise   | 298x220x39mm  |

## Dimensions

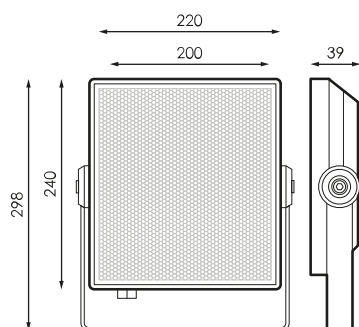

## Photométrie

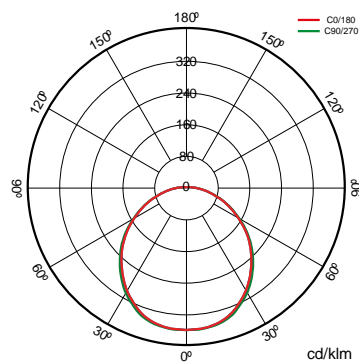

## Info



Jusqu'à épuisement des stocks