

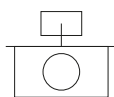

MADE IN SPAIN
Design by PRILUX



Formulários



Escritórios

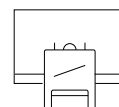

Salas de aula



Retalho



Início

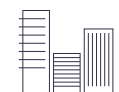

Grandes superfícies



Hotéis





Restaurantes





Cuidados de saúde

Especificações (Luminárias da série)







	Tensão (V)	220-240V
Hz	Frequência (Hz)	50-60Hz
	Intensidade (A)	390mA
ϕ	Fator de Potência (Cos fi)	$\geq 0,9$
	Número de leds	90
	Regulação	Não

	Dimensão	1.414x60x80mm
	Posição de montagem	Superfície

ϕ_{LUM}	Fluxo (lm)	3000lm
--------------	-------------------	--------

	Isolamento elétrico	CCI
---	----------------------------	-----

	Índice de estanqueidade IP	IP20
	Cor do corpo	9006
	Material Difusor	PC-O
	Corpo	AL

	Vida	L70>50000h
---	-------------	------------

	Vida	L70 >50000h
---	-------------	-------------

K	Temperatura de cor	4000K
	CRI Índice de repr. cromática	80cromatica



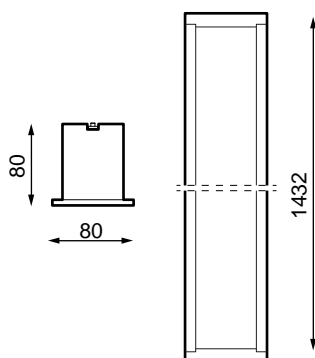

Prilux garante uma tolerância de $\pm 10\%$ nas medições de fluxo de luz.

Dimensões



Referências



	W_{LED}	W		ϕ_{LED}	ϕ_{LUM}	K		
538145	37W	40W	390mA	4930lm	3000lm	4000K	1.414x60x80mm	80cromatica

Fotometria

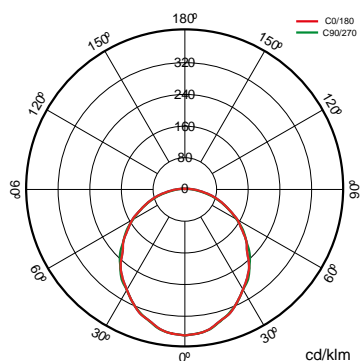

A pedido



Presença e sensor de luz (mod. 1x/2x 1.200mm/1.500mm)



Dali

Bluetooth

K

WAS(*Não compatível para luminárias de 37W)

>80 3.000K

>80 4.000K

>80 4.000K



Cores RAL disponíveis (Consultar)

Acessórios



538237

ACCESORIO
SUPERFICIE LYNX



538244

ACCESORIO
SUSPENSION LYNX



Soluções

S



Pacote CTE

descrição



Regulamento de contribuição da luz natural para atendimento aos requisitos do CTE. Controlo independente de duas linhas de luminárias DALI reguláveis com sensor para instalar numa luminária ou caixa de superfície. Pré-configurado para fácil operação.



Was Indoor

descrição



A solução WAS INDOOR está especialmente orientada para hospitais, residências geriátricas, centros de bem estar, salas de aula, escritórios nos quais se incrementa o bem estar do utilizador. Nos centros de trabalho a iluminação circadiana aplica-se para melhorar as condições visuais, acomodidade e o rendimento dos trabalhadores, o que influencia de modo directo a sua produtividade, que se repercute de modo muito positivo no desenvolvimento da empresa.



Pacote BLUETOOTH

descrição



Dispositivo que permite o controlo da luminária DALI através de qualquer terminal Bluetooth® via APP gratuito que nos oferece controlo de regulação de fluxo, cor, configuração de cena, comportamento vinculado a horários.

Informacje



Para mais informações sobre as diferentes soluções compatíveis com esta luminária, consulte os seguintes códigos BIDI ou na web www.prilux.es

Informacje



Necesita driver DALI