

MADE IN SPAIN
Design by PRILUX

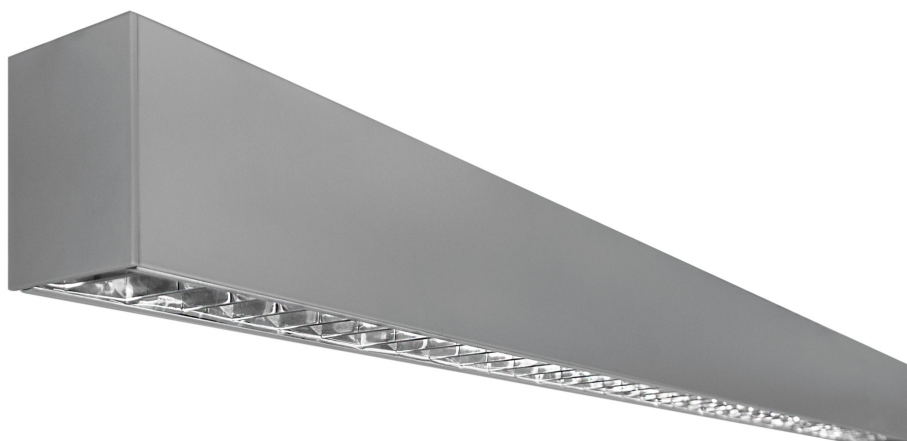

Aplicaciones

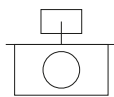

Despachos

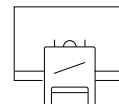

Aulas



Retail



Hogar



Grandes Superficies



Hoteles

















Restaurantes



Cuidado de la salud

Especificaciones (Luminarias de Serie)

	Tensión (V)	220-240V
Hz	Frecuencia (Hz)	50-60Hz
	Intensidad (A)	390mA
ϕ	Factor de potencia (Cos fi)	0.93
	Número de leds	72
	Regulación	No
	IP Índice de estanqueidad	IP20
	IK Protección contra impactos	IK09
	Color cuerpo	9006
	Difusor	AL-SP
	Cuerpo	AL
K	Temperatura de color	4.000K
	CRI Índice de repr. cromática	>80



	Dimensiones	1.133x60x80mm
	Posición de montaje	Superficie/Suspendido
ϕ_{LUM}	Flujo luminoso (lm)	2.286lm
	Aislamiento eléctrico	Cl
	Vida útil	L70>50.000h

Prilux garantiza una tolerancia $\pm 10\%$ en las medidas de flujo lumínico.

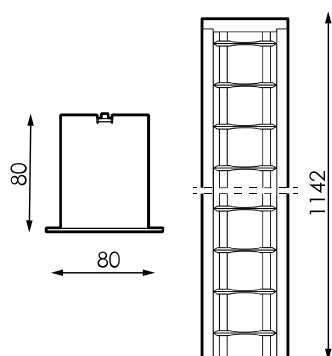
Dimensiones



Referencias

	W_{LED}	W		ϕ_{LED}	ϕ_{LUM}	K	
538152	30W	32W	390mA	3.945lm	2.286lm	4.000K	1.133x60x80mm

Fotometría

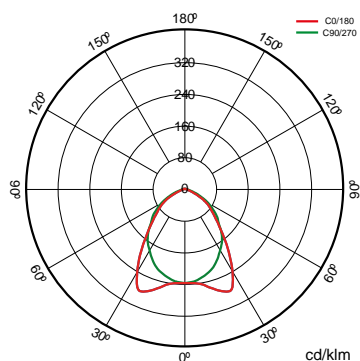

Bajo Pedido



Sensor de presencia y luminosidad



DALI

Bluetooth

K

WAS

>80 3.000K

>80 5.000K

>80 6.500K



Disponible colores RAL (Consultar)

Accesorios



207638

CABLE
ALIMENTACION
TRANS 3X0,75 1M 1PC



538237

ACCESORIO
SUPERFICIE LYNX



538244

ACCESORIO
SUSPENSION LYNX



537933

CABLE ALIM
REGULABLE TRANS
5X0,75 1M 1PC



Soluciones

S



Pack CTE

descripción



Regulación por aporte de luz natural para cumplir con las exigencias del CTE. Control independiente de dos líneas de luminarias regulables DALI con sensor para instalar en luminaria o caja en superficie. Preconfigurado para poner en funcionamiento de manera sencilla.



Pack AULAS

descripción



Regulación por aporte de luz natural y presencia stand alone. Sistema de control de iluminación para cumplir con las exigencias del CTE y optimizar el uso de la energía aprovechando el aporte de luz natural y apagado automático en caso de ausencia.



WAS Indoor

descripción



La solución WAS INDOOR está especialmente orientada a hospitales, residencias geriátricas, centros de wellness, aulas, despachos en los que aumenta el bienestar del usuario. En centros de trabajo la iluminación circadiana se aplica para mejorar las condiciones visuales, la comodidad y el rendimiento de los trabajadores, lo que afectará de manera directa a su productividad, lo cual repercute de manera muy positiva al desarrollo de la empresa.



Pack Bluetooth

descripción



Versión de nuestras luminarias con comunicación Bluetooth Casambi que a través de cualquier terminal Bluetooth® vía APP gratuita nos ofrece el control de regulación de flujo, color, configuración de escenas, comportamiento vinculado a horarios. Múltiples accesorios pueden configurarse para funcionar en la misma red para unificar el control de uno o varios espacios, siendo posible crear grupos, escenas y secuencias dinámicas a medida. El dispositivo Bluetooth® es válido para cualquier luminaria DALI.

Info



Para obtener más información de las diferentes soluciones compatibles con esta luminaria consulte en los siguientes códigos BIDI o en la web www.prilux.es

Info 

Necesita driver DALI