











Spécifications (Luminaires de la série)

| | | |
|---|---|-------------------|
|  | Tension D` Alimentation (V) | 230V |
| Hz | Fréquence (Hz) | 50-60Hz |
| Φ | Facteur de puissance (Cos fi) | >0,55 |
|  | Atténuation | Non |
|  | Type de bague | E27 |
|  | Indice d'étanchéité IP | IP20 |
| K | Température de couleur | 3.000K |
|  | CRI Indice de rendu des couleurs | >80 |
|  | Angle d'ouverture | 35° |
|  | Dimensions | 63x82mm |
|  | Température de service | -5°C~+35 °C |
| Φ_{LUM} | Flux (lm) | 602lm |
|  | Heures de vie | (L70B50>) 25.000h |
|  | CEE Classificatio no énergétique | E |

Les références



|  | W | ϕ |  | ϕ_{LUM} | K |  |
|---|----|--------|---|--------------|--------|---|
| 543224 | 7W | >0,55 | 55mA | 602lm | 3.000K | 63x82mm |

Dimensions



Photométrie

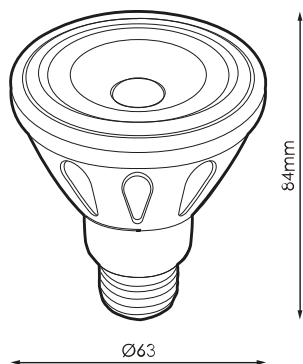

Info



Jusqu'à épuisement des stocks