













Specifications (Series luminaires)

	Voltage (V)	230V
Hz	Frecuency (Hz)	50-60Hz
Φ	Power factor (Cos fi)	>0,55
	Dimming	No
	Bushing type	E27
	IP Tightness index	IP20
K	Colour temperature	3.000K
	CRI Colour rendering index	>80
	Opening angle	35°
	Measures	96x95mm
	Operating temperature	-5°C~+35 °C
Φ_{LUM}	Flux (lm)	919lm
	Lifetime	(L70B50>) 25.000h
	CEE Energy classification	F

References



	W	ϕ		ϕ_{LUM}	K	
543248	10W	>0,55	80mA	919lm	3.000K	96x95mm

Dimensions

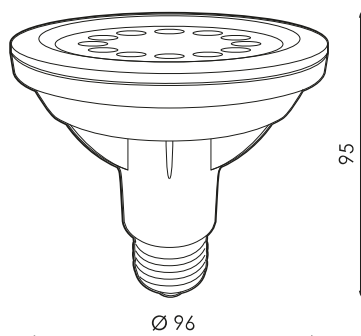

Photometry

