













Spécifications (Luminaires de la série)

	Tension D` Alimentation (V)	230V
Hz	Fréquence (Hz)	50-60Hz
Φ	Facteur de puissance (Cos fi)	>0,55
	Atténuation	Non
	Type de bague	E27
	Indice d'étanchéité IP	IP20
K	Température de couleur	5.000K
	CRI Indice de rendu des couleurs	>80
	Angle d'ouverture	35°
	Dimensions	96x95mm
	Température de service	-5°C~+35 °C
Φ_{LUM}	Flux (lm)	938lm
	Heures de vie	(L70B50>) 25.000h
	CEE Classificationo énergétique	F



Les références



	W	ϕ		ϕ_{LUM}	K	
543255	10W	>0,55	80mA	938lm	5.000K	96x95mm

Dimensions

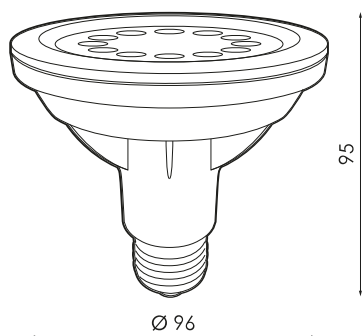

Photométrie

