

MADE IN SPAIN
Design by PRILUX



Applications



Routes



Autoroutes



Parcs



Viaducs



Zones piétonnes



Pistes cyclables



Parkings

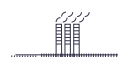

Périmètres















Zones résidentielles

Certifications



Spécifications (Luminaire de la série)



	Tension D` Alimentation (V)	220-240V
Hz	Fréquence (Hz)	50-60Hz
	Intensité (A)	1.000mA
ϕ	Facteur de puissance (Cos fi)	0.97
	Nombre de led	24
	Atténuation	8N - DALI
	Prot. de comm. pour reprogr.	CMR
	Indice d'étanchéité IP	IP66
	IK Protection contre des impacts	IK08
	Couleur du corps	9007
	Matériau du diffuseur	VT-T 5mm
	Corps	AL iap
K	Température de couleur	3.000K
	CRI Indice de rendu des couleurs	>70
	Optique	VA00K0M

	Dimensions	525x255x105mm
	Poids	5Kg
	Résistance au vent	0,151m2
	L'assemblée	Monture en crose
	Température de service	-40~+35°C
	Flux (lm)	8767lm
	Isolation électrique	CI
	Heures de vie	L90 B10 >200.000h
ϕ/W	Efficacité	118lm/W

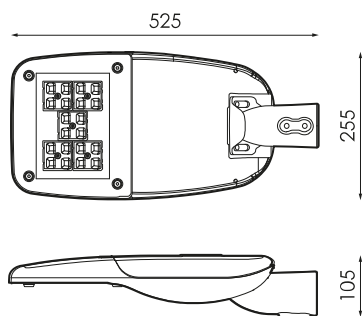

Prilux garantit une tolérance de $\pm 10\%$ dans les mesures de flux lumineux.

Dimensions



Les références



	W_{LED}	W		ϕ	ϕ_{LED}	ϕ_{LUM}	ϕ/W		K
568975	72W	74,6W	1000mA	11400lm	10563lm	8767lm	118lm/W	24	3.000K

Photométrie

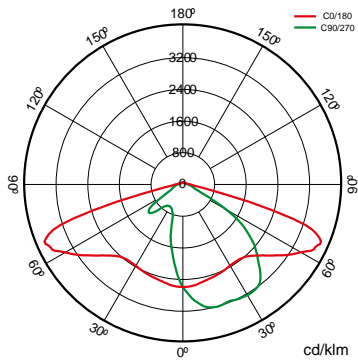

Sur demande



Dali

Double niveau avec ligne de commande

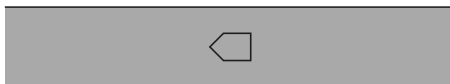

Classe II



PC-T (IK10)

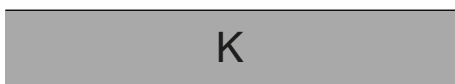

PCAmbre

>70 2.700K

>80 3.000K

>80 4.000K

Filtre ambré pour PC

>70 2.700K



Couleurs RAL disponibles (Consulter)

50 °C (Consulter les puissances et optiques disponibles)



PPDL0M

PPIL0M

S150L0M

VA00I0P

VA00L0M

VA01L0M

VA02L0M

VA03D0P

VA04D0P

VA05I0P

VA06I0P



VA07L0P

VA08L0M

PEXL0M

Forfaits légers



			PCA	722	727	730	827	830	840
W			ϕ_{LUM} ϕ/W	ϕ_{LUM} ϕ/W	ϕ_{LUM} ϕ/W	ϕ_{LUM} ϕ/W	ϕ_{LUM} ϕ/W	ϕ_{LUM} ϕ/W	ϕ_{LUM} ϕ/W
74,6W	24	1.000mA		7.039lm 94lm/W	8.288lm 111lm/W	8.767lm 118lm/W	7.495lm 100lm/W	7.495lm 100lm/W	7.900lm 106lm/W

Montage



1. Monture en crosse

Accessoires



534222

KIT ADAPT. POUR
MAT DE Ø50MM
AVATAR

538282

KIT ADAPT. POUR
MAT DE Ø42MM
AVATAR

479776

KIT ADAPT. POUR
MAT DE Ø33MM
AVATAR

501743

KIT ADAPT. POUR
MAT DE Ø76MM
POLIVALENT POUR
LANTERNES
ECLAIRAGE ROUTIER
RAL9007T



Les technologies



Overstorm



La technologie OVERSTORM est conçue pour les luminaires qui font normalement face à des environnements électriquement agressifs. Il fournit au produit trois sphères de protection : dans la sphère externe, un parasurtenseur indépendant supprime les surtensions éventuelles, dans la sphère intermédiaire, les pilotes sont préparés pour résister à des pics de tension allant jusqu'à 6 kV et 10 kV. Dans la sphère nucléaire, la protection dans le module LED est assurée aussi bien à son entrée, que pour les petites surtensions qui n'ont pas été filtrées par les sphères extérieures.



SystemShield



La technologie SYSTEMSHIELD est conçue pour garantir les heures de vie utile des luminaires installés dans des environnements où le dépassement de la température maximale de fonctionnement est possible et même probable. Grâce à des sondes thermiques, le luminaire connaît à tout moment sa température de fonctionnement.



CMR



CMR (CORA MANAGER READY) identifie les luminaires prilux compatibles avec le système CORA MANAGER qui fournit aux luminaires un contrôle de régulation et de programmation.



WAS



La technologie WAS (White Adaptive System) offre aux luminaires PRILUX la possibilité de modifier à la fois la quantité de lumière qu'ils fournissent et la température de couleur corrélée, CCT.

Des règles



Conforme aux exigences de l'IDAE et de la CEI, ainsi qu'au décret 1890/2008 (règlement sur l'efficacité énergétique de l'éclairage extérieur).



Solutions

S



Was Outdoor

la description



La technologie WAS (White Adaptive System) offre aux luminaires PRILUX la possibilité de modifier à la fois la quantité de lumière qu'ils fournissent et la température de couleur corrélée, CCT. La technologie WAS (White Adaptive System) offre aux luminaires PRILUX la possibilité de modifier à la fois la quantité de lumière qu'ils fournissent et la température de couleur corrélée.



Cora Manager

la description



L'éclairage est l'un des éléments clés pour tracer la voie vers les villes intelligentes. Les systèmes de gestion de l'éclairage progressent à pas de géant, privilégiant des objectifs prioritaires tels que la qualité de service, la réduction des coûts et le respect de l'environnement. CORA Manager est le système de contrôle développé par Prilux qui, associé à nos luminaires compatibles qui permet une gestion intelligente de l'éclairage public, en maintenant l'harmonie entre le développement durable et la qualité de vie des citoyens, tout en favorisant la sécurité et l'économie.



Safelight

la description



SAFELIGHT permet l'éclairage de passages piétons avec des luminaires adaptés avec des optiques spéciales pour cette application qui éclairent avec une lumière blanche avec un niveau continu de 100%.

Info



Pour plus d'informations sur les différentes solutions compatibles avec ce luminaire, consultez les codes BIDI suivants ou sur le web www.prilux.es