

MADE IN SPAIN
Design by PRILUX



Applications



Roads



Motorways

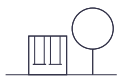

Parks



Viaducts



Residential Areas



Pedestrian Zones



Residential Areas



Cycle lanes





















Car parks

Certifications



Specifications (Series luminaires)

	Voltage (V)	220-240V
Hz	Frecuency (Hz)	50-60Hz
	Current (A)	350mA
ϕ	Power factor (Cos fi)	0.95
	LED number	48
	Dimming	8N - DALI
	Comm. Prot. for reprogr.	CMR
	IP Tightness index	IP66
	IK Impact resistance	IK08
	Body color	9007
	Diffuser Material	VT-T 5mm
	Body	AL iap
K	Colour temperature	4.000K
	CRI Colour rendering index	>70
	Optical	VA00K0M



	Measures	625x290x105mm
	Weight	7Kg
	Wind Resistance	0,18m2
	Mounting	Crosier Mount
	Operating temperature	-40~+50°C
ϕ_{LUM}	Flux (lm)	7463lm
	Electrical isolation	CI
	Lifetime	L90 B10 >200.000h
ϕ/W	Efficacy	148lm/W

Prilux guarantees a $\pm 10\%$ tolerance in light flux measurements.

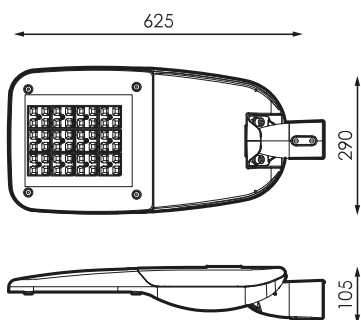
Dimensions



References

	W_{LED}	W		ϕ	ϕ_{LED}	ϕ_{LUM}	ϕ/W		K
569347	48W	50,4W	350mA	9596lm	8578lm	7463lm	148lm/W	48	4.000K

Photometry

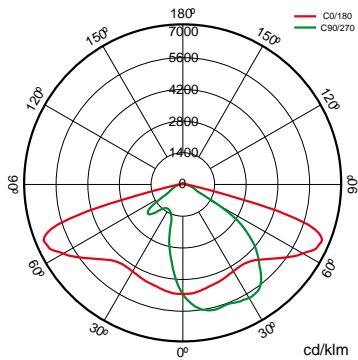

On request





Dali

Double Level with Line of Command



Class II



PC-T (IK10)

K

PCAmbar

>70 2.700K

>80 3.000K

>80 4.000K

PC Amber Filter

>70 2.700K



Available RAL colors (Consult)

50 °C (Consult available powers and optics)



PPDL0M

PPIL0M

S150L0M

VA00I0P

VA00L0M

VA01L0M

VA02L0M

VA03D0P

VA04D0P



VA05I0P

VA06I0P

VA07L0P

Light packages



			PCA	722	727	730	827	830	840
W			ϕ_{LUM} ϕ/W	ϕ_{LUM} ϕ/W	ϕ_{LUM} ϕ/W	ϕ_{LUM} ϕ/W	ϕ_{LUM} ϕ/W	ϕ_{LUM} ϕ/W	ϕ_{LUM} ϕ/W
50,4W	48	350mA	3.994lm 79lm/W	5.763lm 114lm/W	6.800lm 135lm/W	7.132lm 142lm/W	6.136lm 122lm/W	6.136lm 122lm/W	6.468lm 128lm/W

Mounting

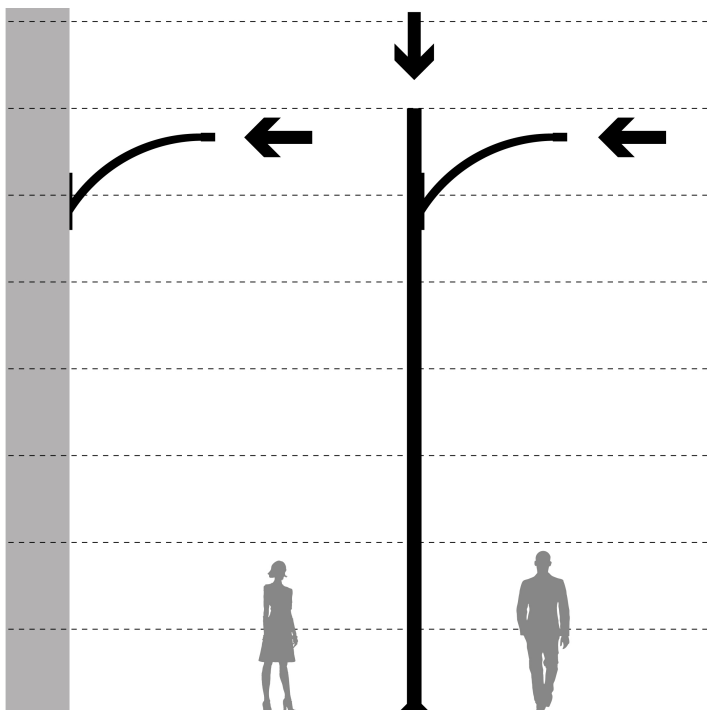

1. Crosier Mount

Accessories



534222

KIT ADAP. TO POST
50MM AVATAR



538282

KIT ADAP. A POSTE
Ø42MM AVATAR



479776

KIT ADAP. A POSTE
Ø33MM AVATAR



501743

KIT ADAP. A POSTE
Ø76MM
POLIVALENTE TECN.
RAL9007T



Technologies



Overstorm



OVERSTORM technology is designed for those luminaires that normally face electrically aggressive environments. It provides the product with three spheres of protection: In the outer sphere, an independent surge protector suppresses eventual voltage surges, in the intermediate sphere the drivers are prepared to withstand voltage peaks of up to 6 kV and 10kV. In the nuclear sphere, the protection in the LED module is provided both at its input, for small surges that have not been filtered by the external spheres.



SystemShield



SYSTEMSHIELD technology is designed to guarantee the hours of useful life of luminaires installed in environments where exceeding the maximum operating temperature is possible and even probable. Using thermal probes, the luminaire knows its operating temperature at all times.



CMR



CMR (CORA MANAGER READY) identifies the prilux luminaires compatible with the CORA MANAGER system that provides the luminaires with control, regulation and programming.



WAS



WAS (White Adaptive System) technology provides PRILUX luminaires with the ability to change both the amount of light they provide and the correlated color temperature, CCT.

Rules



Complies with IDAE and CEI requirements; and with R.D. 1890/2008 (Regulation on energy efficiency of outdoor lighting).

Solutions

S



Was Outdoor

description



WAS (White Adaptive System) technology provides PRILUX luminaires with the ability to change both the amount of light they provide and the correlated color temperature, CCT. WAS (White Adaptive System) technology provides PRILUX luminaires with the ability to change both the amount of light they provide and the correlated color temperature



Safelight

description



SAFELIGHT allows the lighting of zebra crossings with road luminaires adapted with special optics for this application that illuminate with white light with a continuous level of 100%



Cora Manager

description



One of the key pieces to achieve the path towards smart cities is lighting. Lighting management systems are advancing by leaps and bounds, prioritizing primary objectives such as service quality, cost reduction and care for the environment. CORA Manager is the control system developed by Prilux that, together with our compatible luminaires that provides intelligent management of public lighting, maintaining harmony between sustainable development and quality of life for citizens, while promoting safety and saving.

Info



For more information on the different solutions compatible with this luminaire, consult the following BIDI codes or on the web www.prilux.es