

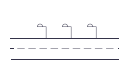

MADE IN SPAIN
Design by PRILUX



Formulários



Estradas



Auto-estradas

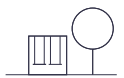

Parques



Viadutos



Áreas Residenciais



Zonas pedonais



Áreas Residenciais



Faixas para













Estacionamentos

Certificações



Especificações (Luminárias da série)

	Tensão (V)	220-240V
Hz	Frequência (Hz)	50-60Hz
	Intensidade (A)	900mA
ϕ	Fator de Potência (Cos fi)	0.98
	Número de leds	48
	Regulação	Não
	Índice de estanqueidade IP	IP66
	IK Proteção contra impactos	IK08
	Cor do corpo	9007
	Material Difusor	VT-T 5mm
	Corpo	AL iap
K	Temperatura de cor	4000K
	CRI Índice de repr. cromática	70cromatica
	Óptica	VA00K0M



	Dimensão	625x290x105mm
	Peso	7Kg
	Resistência ao vento	0,18m2
	Assembly	Monte Crúzio
	Temperatura de trabalho	35°C
ϕ_{LUM}	Fluxo (lm)	16483lm
	Isolamento elétrico	CCI
	Vida	L90B10>200000h
	Vida	L90 B10 >200.000h
ϕ/W	Eficácia	122lm/W

Prilux garante uma tolerância de $\pm 10\%$ nas medições de fluxo de luz.

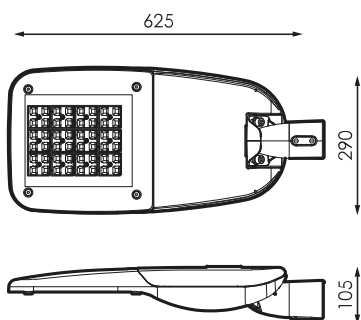
Dimensões



Referências

	W_{LED}	W		ϕ	ϕ_{LED}	ϕ_{LUM}	ϕ/W		K
569378	128W	134,6W	900mA	21899lm	18946lm	16483lm	122lm/W	48	4000K

Fotometria

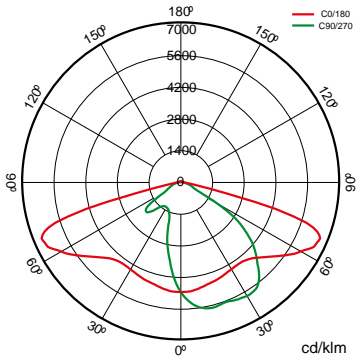

A pedido



Dali

Nível duplo com linha de comando



Classe II



PC-T (IK10)



PCAmber

>70 2.700K

>80 3.000K

>80 4.000K

PC Filtro Âmbar

>70 2.700K



Cores RAL disponíveis (Consultar)

50 °C (Consulte potências e óticas disponíveis)



PPDL0M

PPIL0M

S150L0M

VA00I0P

VA00L0M

VA01L0M

VA02L0M

VA03D0P

VA04D0P



VA05I0P

VA06I0P

VA07L0P

Pacotes leves



			PCA	722	727	730	827	830	840
W			ϕ_{LUM} ϕ/W	ϕ_{LUM} ϕ/W	ϕ_{LUM} ϕ/W	ϕ_{LUM} ϕ/W	ϕ_{LUM} ϕ/W	ϕ_{LUM} ϕ/W	ϕ_{LUM} ϕ/W
134,6W	48	900mA		12.728lm 95lm/W	15.018lm 112lm/W	15.750lm 117lm/W	13.553lm 101lm/W	13.553lm 101lm/W	14.285lm 106lm/W

Montagem



1. Monte Crúzio



Acessórios



534222

KIT ADAP. PARA
POSTAR AVATAR DE
50 MM



538282

KIT ADAP. A POSTE
Ø42MM AVATAR



501743

KIT ADAP. A POSTE
Ø76MM
POLIVALENTE TECN.
RAL9007T



Tecnologias



Overstorm



A tecnologia OVERSTORM foi projetada para as luminárias que normalmente enfrentam ambientes eletricamente agressivos. Fornece ao produto três esferas de proteção: Na esfera externa, um estabilizador independente suprime eventuais picos de tensão, na esfera intermediária os drivers são preparados para suportar picos de tensão de até 6 kV e 10 kV. Na esfera nuclear, a proteção no módulo de LED é fornecida tanto na sua entrada, para pequenos surtos que não foram filtrados pelas esferas externas.

SystemShield



A tecnologia SYSTEMSHIELD foi concebida para garantir as horas de vida útil das luminárias instaladas em ambientes onde ultrapassar a temperatura máxima de funcionamento é possível e mesmo provável. Usando sondas térmicas, a luminária sabe sua temperatura operacional em todos os momentos.



CMR



O CMR (CORA MANAGER READY) identifica as luminárias prilux compatíveis com o sistema CORA MANAGER que fornece às luminárias o controle de regulação e programação.

Regras



Níveis programables



Cora Gerente

descrição



Gestão da iluminação no quadro elétrico que permite o controlo em grupo das luminárias ligadas ao centro de controlo através da linha de alimentação (CMR) sem cablagem adicional

Informacje



Para mais informações sobre as diferentes soluções compatíveis com esta luminária, consulte os seguintes códigos BIDI ou na web www.prilux.es