

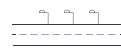

MADE IN SPAIN  
Design by PRILUX



## Applications



Roads



Motorways

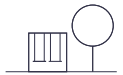

Parks



Viaducts



Residential Areas



Pedestrian Zones



Residential Areas



Cycle lanes





















Car parks

## Certifications



## Specifications (Series luminaires)

	<b>Voltage (V)</b>	220-240V
Hz	<b>Frecuency (Hz)</b>	50-60Hz
	<b>Current (A)</b>	1.000mA
$\phi$	<b>Power factor (Cos fi)</b>	0.98
	<b>LED number</b>	48
	<b>Dimming</b>	8N - DALI
	<b>Comm. Prot. for reprogr.</b>	CMR
	<b>IP Tightness index</b>	IP66
	<b>IK Impact resistance</b>	IK08
	<b>Body color</b>	9007
	<b>Diffuser Material</b>	VT-T 5mm
	<b>Body</b>	AL iap
<b>K</b>	<b>Colour temperature</b>	4.000K
	<b>CRI Colour rendering index</b>	>70
	<b>Optical</b>	VA0010P



	<b>Measures</b>	625x290x105mm
	<b>Weight</b>	7Kg
	<b>Wind Resistance</b>	0,18m2
	<b>Mounting</b>	Crosier Mount
	<b>Operating temperature</b>	-40~+35°C
$\phi_{LUM}$	<b>Flux (lm)</b>	17810lm
	<b>Electrical isolation</b>	CI
	<b>Lifetime</b>	L90 B10 >200.000h
$\phi/W$	<b>Efficacy</b>	121lm/W

Prilux guarantees a  $\pm 10\%$  tolerance in light flux measurements.

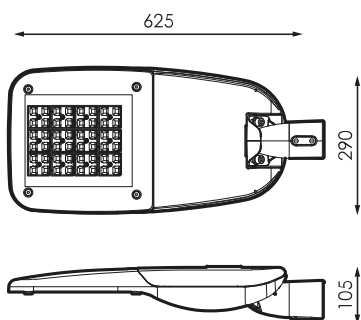
## Dimensions



## References

	$W_{LED}$	$W$		$\phi$	$\phi_{LED}$	$\phi_{LUM}$	$\phi/W$		<b>K</b>
<b>569385</b>	144W	146,7W	1000mA	23860lm	20471lm	17810lm	121lm/W	48	4.000K

## Photometry

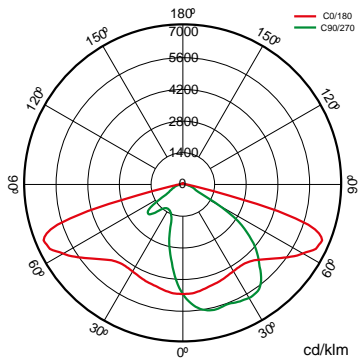

## On request



Dali

Double Level with Line of Command

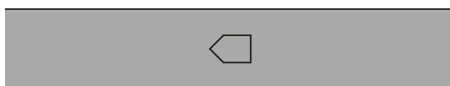

Class II



PC-T (IK10)

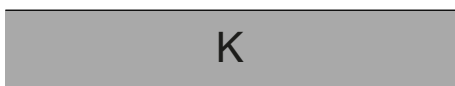

PCAmbar

>70 2.700K

>80 3.000K

>80 4.000K

PC Amber Filter

>70 2.700K



Available RAL colors (Consult)

50 °C (Consult available powers and optics)



PPDL0M

PPIL0M

SI50L0M

VA00I0P

VA00L0M

VA01L0M

VA02L0M

VA03D0P

VA04D0P

VA05I0P

VA06I0P

VA07L0P

## Mounting

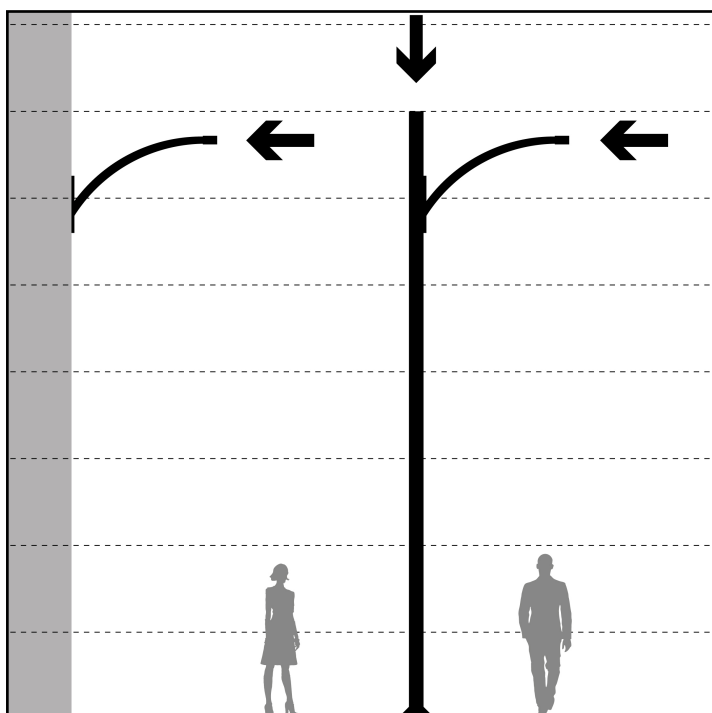

1. Crosier Mount

## Accessories



**534222**

KIT ADAP. TO POST  
50MM AVATAR



**538282**

KIT ADAP. A POSTE  
Ø42MM AVATAR



**479776**

KIT ADAP. A POSTE  
Ø33MM AVATAR



**501743**

KIT ADAP. A POSTE  
Ø76MM  
POLIVALENTE TECN.  
RAL9007T



## Technologies



### Overstorm



OVERSTORM technology is designed for those luminaires that normally face electrically aggressive environments. It provides the product with three spheres of protection: In the outer sphere, an independent surge protector suppresses eventual voltage surges, in the intermediate sphere the drivers are prepared to withstand voltage peaks of up to 6 kV and 10kV. In the nuclear sphere, the protection in the LED module is provided both at its input, for small surges that have not been filtered by the external spheres.

### SystemShield



SYSTEMSHIELD technology is designed to guarantee the hours of useful life of luminaires installed in environments where exceeding the maximum operating temperature is possible and even probable. Using thermal probes, the luminaire knows its operating temperature at all times.



### CMR



CMR (CORA MANAGER READY) identifies the prilux luminaires compatible with the CORA MANAGER system that provides the luminaires with control, regulation and programming.



### WAS



WAS (White Adaptive System) technology provides PRILUX luminaires with the ability to change both the amount of light they provide and the correlated color temperature, CCT.

## Rules



Complies with IDAE and CEI requirements; and with R.D. 1890/2008 (Regulation on energy efficiency of outdoor lighting).

## Solutions

S



### Was Outdoor

#### description



WAS (White Adaptive System) technology provides PRILUX luminaires with the ability to change both the amount of light they provide and the correlated color temperature, CCT. WAS (White Adaptive System) technology provides PRILUX luminaires with the ability to change both the amount of light they provide and the correlated color temperature



### Safelight

#### description



SAFELIGHT allows the lighting of zebra crossings with road luminaires adapted with special optics for this application that illuminate with white light with a continuous level of 100%



### Cora Manager

#### description



One of the key pieces to achieve the path towards smart cities is lighting. Lighting management systems are advancing by leaps and bounds, prioritizing primary objectives such as service quality, cost reduction and care for the environment. CORA Manager is the control system developed by Prilux that, together with our compatible luminaires that provides intelligent management of public lighting, maintaining harmony between sustainable development and quality of life for citizens, while promoting safety and saving.

#### Info



For more information on the different solutions compatible with this luminaire, consult the following BIDI codes or on the web [www.prilux.es](http://www.prilux.es)