

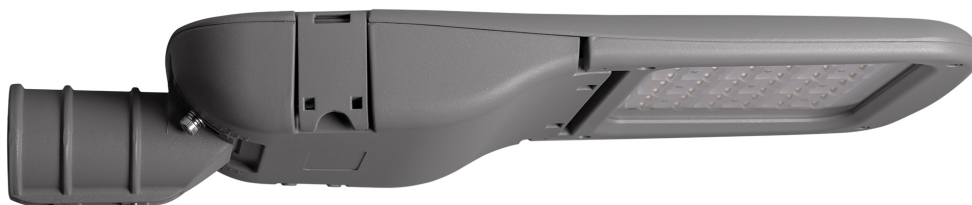

MADE IN SPAIN  
Design by PRILUX



## Applications



Autoroutes



Routes



Pistes cyclables



Parcs



Viaducs



Zones piétonnes



Zones résidentielles



Tunnels





















Parkings

## Certifications



## Spécifications (Luminaire de la série)

	<b>Tension D` Alimentation (V)</b>	220-240V
Hz	<b>Fréquence (Hz)</b>	50-60Hz
	<b>Intensité (A)</b>	500mA
$\phi$	<b>Facteur de puissance (Cos fi)</b>	0.97
	<b>Nombre de led</b>	48
	<b>Atténuation</b>	8N - DALI
	<b>Prot. de comm. pour reprogr.</b>	CMR
	<b>Indice d'étanchéité IP</b>	IP66
	<b>IK Protection contre des impacts</b>	IK10
	<b>Couleur du corps</b>	9007
	<b>Matériau du diffuseur</b>	VT-T
	<b>Corps</b>	AL iap
<b>K</b>	<b>Température de couleur</b>	4.000K
	<b>CRI Indice de rendu des couleurs</b>	>70
	<b>Optique</b>	VA00K0M

	<b>Dimensions</b>	640x280x112mm
	<b>Résistance au vent</b>	0,179m2
	<b>L'assemblée</b>	Monture en crose
	<b>Température de service</b>	-40~+50°C
$\phi_{LUM}$	<b>Flux (lm)</b>	10.787lm
	<b>Isolation électrique</b>	CI
	<b>Heures de vie</b>	L90 B10 >200.000h
$\phi/W$	<b>Efficacité</b>	148lm/W

Prilux garantit une tolérance de  $\pm 10\%$  dans les mesures de flux lumineux.

## Dimensions

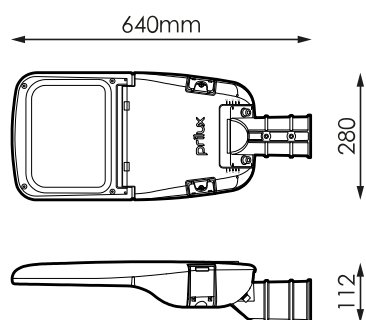

## Les références

	$W_{LED}$	$W$		$\phi$	$\phi_{LED}$	$\phi_{LUM}$	$\phi/W$		<b>K</b>
<b>569897</b>	72W	73W	500mA	13.241lm	12.691lm	10.787lm	148lm/W	48	4.000K

## Photométrie

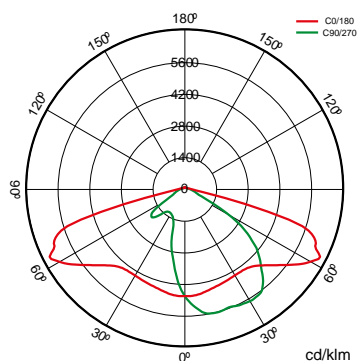

## Sur demande



Dali

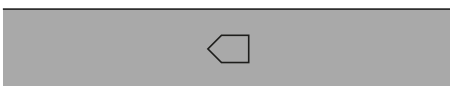

Classe II



PC-T (IK10)



Couleurs RAL disponibles (Consulter)

50 °C (Consulter les puissances et optiques disponibles)



VA03D0P

VA04D0P

VA05D0P

VA06D0P

VA07D0P



>70 2.700K



>80 3.000K

>80 4.000K

>70 2.700K

## Forfaits légers



			PCA	722	727	730	827	830	840
W			$\phi_{LUM}$ $\phi/W$	$\phi_{LUM}$ $\phi/W$	$\phi_{LUM}$ $\phi/W$	$\phi_{LUM}$ $\phi/W$	$\phi_{LUM}$ $\phi/W$	$\phi_{LUM}$ $\phi/W$	$\phi_{LUM}$ $\phi/W$
<b>73W</b>	48	500mA	5.628lm 77lm/W	8.330lm 114lm/W	9.828lm 135lm/W		10.435lm 8.869lm/W	8.869lm 121lm/W	9.349lm 128lm/W

## Montage



1. Monture en crosse

**Accessoires**



**586566**

KIT ADAPT. POUR  
MAT DE Ø33MM  
VERSA-ARISA ROAD

**496636**

KIT ADAPT. POUR  
MAT DE Ø42MM  
VERSA-ARISA ROAD

**496629**

KIT ADAPT. POUR  
MAT DE Ø50MM  
VERSA-ARISA ROAD

**501743**

KIT ADAPT. POUR  
MAT DE Ø76MM  
POLIVALENT POUR  
LANTERNES  
ECLAIRAGE ROUTIER  
RAL9007T



## Les technologies



### Overstorm



La technologie OVERSTORM est conçue pour les luminaires qui font normalement face à des environnements électriquement agressifs. Il fournit au produit trois sphères de protection : dans la sphère externe, un parasurtenseur indépendant supprime les surtensions éventuelles, dans la sphère intermédiaire, les pilotes sont préparés pour résister à des pics de tension allant jusqu'à 6 kV et 10 kV. Dans la sphère nucléaire, la protection dans le module LED est assurée aussi bien à son entrée, que pour les petites surtensions qui n'ont pas été filtrées par les sphères extérieures.

### SystemShield



La technologie SYSTEMSHIELD est conçue pour garantir les heures de vie utile des luminaires installés dans des environnements où le dépassement de la température maximale de fonctionnement est possible et même probable. Grâce à des sondes thermiques, le luminaire connaît à tout moment sa température de fonctionnement.



### CMR



CMR (CORA MANAGER READY) identifie les luminaires prilux compatibles avec le système CORA MANAGER qui fournit aux luminaires un contrôle de régulation et de programmation.



## Cora Manager

### la description



L'éclairage est l'un des éléments clés pour tracer la voie vers les villes intelligentes. Les systèmes de gestion de l'éclairage progressent à pas de géant, privilégiant des objectifs prioritaires tels que la qualité de service, la réduction des coûts et le respect de l'environnement. CORA Manager est le système de contrôle développé par Prilux qui, associé à nos luminaires compatibles qui permet une gestion intelligente de l'éclairage public, en maintenant l'harmonie entre le développement durable et la qualité de vie des citoyens, tout en favorisant la sécurité et l'économie.

### Info



Pour plus d'informations sur les différentes solutions compatibles avec ce luminaire, consultez les codes BIDI suivants ou sur le web [www.prilux.es](http://www.prilux.es)