

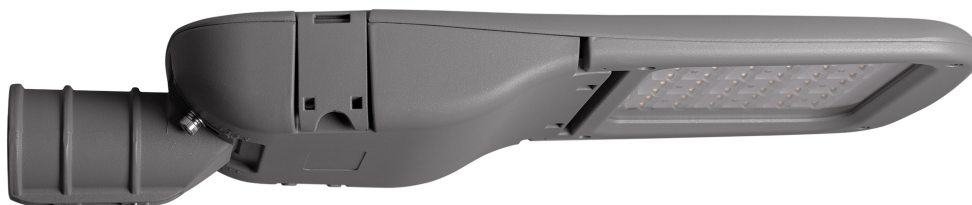

MADE IN SPAIN
Design by PRILUX



Aplicaciones



Autovías



Carreteras



Carril bici



Parques



Viaductos



Zonas Peatonales



Zonas Residenciales



Túneles





















Parkings

Certificaciones



Especificaciones (Luminarias de Serie)

	Tensión (V)	220-240V
Hz	Frecuencia (Hz)	50-60Hz
	Intensidad (A)	700mA
ϕ	Factor de potencia (Cos fi)	0.98
	Número de leds	48
	Regulación	8N - DALI
	Prot. de com. para reprogr.	CMR
	IP Índice de estanqueidad	IP66
	IK Protección contra impactos	IK10
	Color cuerpo	9007
	Difusor	VT-T
	Cuerpo	AL iap
K	Temperatura de color	3.000K
	CRI Índice de repr. cromática	>70
	Óptica	VA00K0M



	Dimensiones	640x280x112mm
	Resistencia al Viento	0,179m2
	Montaje	Montaje en Báculo
	Temp. de funcionamiento	-40~+35°C
ϕ_{LUM}	Flujo luminoso (lm)	13.520lm
	Aislamiento eléctrico	CI
	Vida útil	L90 B10 >200.000h
ϕ/W	Eficacia	133lm/W

Prilux garantiza una tolerancia $\pm 10\%$ en las medidas de flujo lumínico.

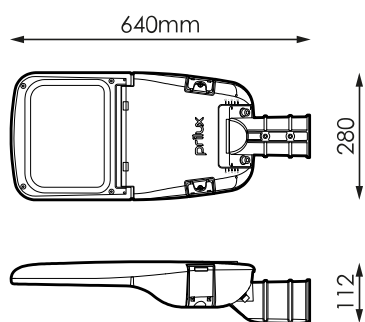
Dimensiones



Referencias

	W_{LED}	W		ϕ	ϕ_{LED}	ϕ_{LUM}	ϕ/W		K
569958	96W	101,8W	700mA	16.958lm	15.906lm	13.520lm	133lm/W	48	3.000K

Fotometría

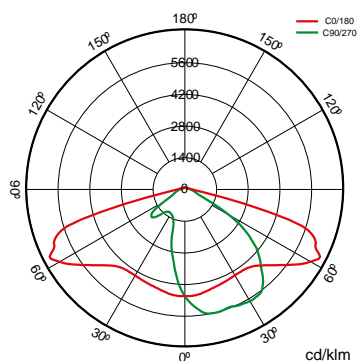

Bajo Pedido



DALI

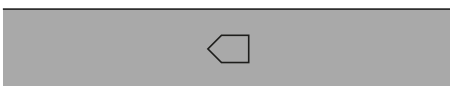

Clase II



PC-T (IK10)



Disponible colores RAL (Consultar)

+50 °C (Consultar potencias y ópticas disponibles)



VA03D0P

VA04D0P

VA05D0P

VA06D0P

VA07D0P

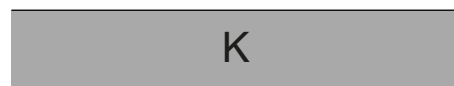

>70 2.700K



>80 3.000K

>80 4.000K

>70 2.200K

Paquetes lumínicos



			PCA		722		727		730		827		830		840	
W			ϕ_{LUM}	ϕ/W	ϕ_{LUM}	ϕ/W	ϕ_{LUM}	ϕ/W	ϕ_{LUM}	ϕ/W	ϕ_{LUM}	ϕ/W	ϕ_{LUM}	ϕ/W	ϕ_{LUM}	ϕ/W
101,8W	48	700mA	7.165lm	70lm/W	10.926lm	107lm/W	12.891lm	127lm/W			13.687lm	11.634lm/W	11.634lm	114lm/W	12.262lm	120lm/W

Montaje



1. Montaje en Báculo

Accesorios



586566

KIT ADAP. A POSTE
Ø33MM VERSA-
ARISA ROAD

496636

KIT ADAP. A POSTE
Ø42MM VERSA-
ARISA ROAD

496629

KIT ADAP. A POSTE
Ø50MM VERSA-
ARISA ROAD

501743

KIT ADAP. A POSTE
Ø76MM
POLIVALENTE TECN.
RAL9007T



Tecnologías



Overstorm



La tecnología OVERSTORM está pensada para aquellas luminarias que normalmente se enfrentan a entornos eléctricamente agresivos. Dota al producto de tres esferas de protección: En la esfera exterior un protector contra sobretensiones independiente suprime las eventuales subidas de tensión, la esfera intermedia los drivers están preparados para soportar picos de tensión de hasta 6 kV y 10kV. En la esfera nuclear la protección en el módulo LED se proporciona tanto en su entrada, para las pequeñas sobretensiones que no han sido filtradas por las esferas externas.

SystemShield



La tecnología SYSTEMSHIELD está pensada para garantizar las horas de vida útil de luminarias instaladas en entornos en los que superar la temperatura máxima de operación es posible e incluso probable. Mediante sondas térmicas la luminaria conoce en todo momento su temperatura de funcionamiento.



CMR



CMR (CORA MANAGER READY) identifica a las luminarias de prilux compatibles con el sistema CORA MANAGER que dota a las luminarias de control regulación y programación.



Cora Manager

descripción



La iluminación es clave para ciudades inteligentes. Los sistemas de gestión de alumbrado avanzan rápidamente con enfoque en calidad, reducción de costes y cuidado ambiental. CORA Manager de Prilux, junto con nuestras luminarias, ofrece gestión inteligente de alumbrado público para desarrollo sostenible, calidad de vida, seguridad y ahorro.

Info



Para obtener más información de las diferentes soluciones compatibles con esta luminaria consulte en los siguientes códigos BIDI o en la web www.prilux.es