

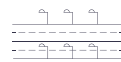

MADE IN SPAIN
Design by PRILUX



Applications



Autoroutes



Routes



Pistes cyclables



Parcs



Viaducs



Zones piétonnes



Zones résidentielles



Tunnels





















Parkings

Certifications



Spécifications (Luminaires de la série)

	Tension D` Alimentation (V)	220-240V
Hz	Fréquence (Hz)	50-60Hz
	Intensité (A)	900mA
ϕ	Facteur de puissance (Cos fi)	0.98
	Nombre de led	48
	Atténuation	8N - DALI
	Prot. de comm. pour reprogr.	CMR
	Indice d'étanchéité IP	IP66
	IK Protection contre des impacts	IK10
	Couleur du corps	9007
	Matériau du diffuseur	VT-T
	Corps	AL iap
K	Température de couleur	3.000K
	CRI Indice de rendu des couleurs	>70
	Optique	VA00K0M



	Dimensions	640x280x112mm
	Résistance au vent	0,179m2
	L'assemblée	Monture en crose
	Température de service	-40~+35°C
ϕ_{LUM}	Flux (lm)	16.523lm
	Isolation électrique	CI
	Heures de vie	L90 B10 >200.000h
ϕ/W	Efficacité	123lm/W

Prilux garantit une tolérance de $\pm 10\%$ dans les mesures de flux lumineux.

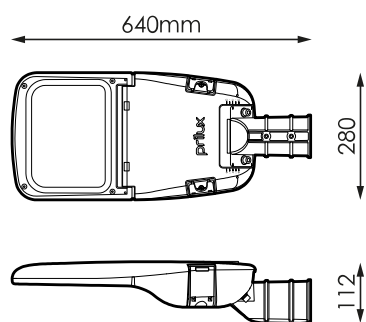
Dimensions



Les références

	W_{LED}	W		ϕ	ϕ_{LED}	ϕ_{LUM}	ϕ/W		K
569965	128W	134,6W	900mA	20.925lm	19.439lm	16.523lm	123lm/W	48	3.000K

Photométrie

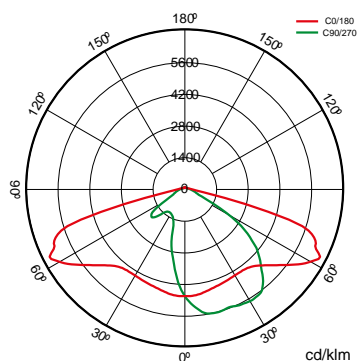

Sur demande



Dali



Classe II



PC-T (IK10)



Couleurs RAL disponibles (Consulter)

50 °C (Consulter les puissances et optiques disponibles)



PEXL0M

PPDL0M

PPILOM

SI50L0M

VA00I0P

VA00L0M

VA01L0M

VA02L0M

VA03D0P

VA04D0P

VA05D0P

VA06D0P

VA07D0P

VA08D0P

K

>70 2.700K



>80 3.000K

>80 4.000K

>70 2.700K

Forfaits légers



			PCA	722	727	730	827	830	840
W			ϕ_{LUM} ϕ/W	ϕ_{LUM} ϕ/W	ϕ_{LUM} ϕ/W	ϕ_{LUM} ϕ/W	ϕ_{LUM} ϕ/W	ϕ_{LUM} ϕ/W	ϕ_{LUM} ϕ/W
134,6W	48	900mA		13.353lm 99lm/W	15.755lm 117lm/W		16.727lm 14.218lm/W	14.218lm 106lm/W	14.986lm 111lm/W

Montage

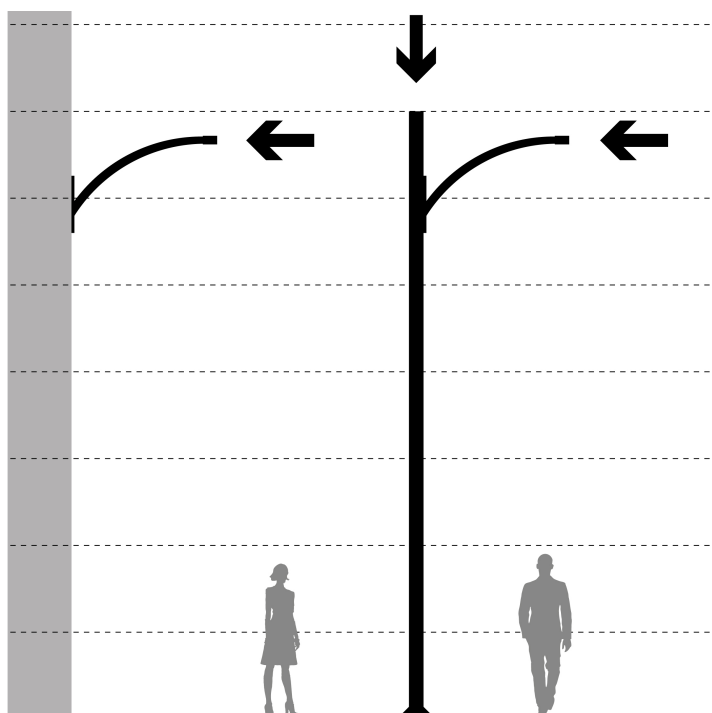

1. Monture en crosse

Accessoires



586566

KIT ADAPT. POUR
MAT DE Ø33MM
VERSA-ARISA ROAD

496636

KIT ADAPT. POUR
MAT DE Ø42MM
VERSA-ARISA ROAD

496629

KIT ADAPT. POUR
MAT DE Ø50MM
VERSA-ARISA ROAD

501743

KIT ADAPT. POUR
MAT DE Ø76MM
POLIVALENT POUR
LANTERNES
ECLAIRAGE ROUTIER
RAL9007T



Les technologies



Overstorm



La technologie OVERSTORM est conçue pour les luminaires qui font normalement face à des environnements électriquement agressifs. Il fournit au produit trois sphères de protection : dans la sphère externe, un parasurtenseur indépendant supprime les surtensions éventuelles, dans la sphère intermédiaire, les pilotes sont préparés pour résister à des pics de tension allant jusqu'à 6 kV et 10 kV. Dans la sphère nucléaire, la protection dans le module LED est assurée aussi bien à son entrée, que pour les petites surtensions qui n'ont pas été filtrées par les sphères extérieures.

SystemShield



La technologie SYSTEMSHIELD est conçue pour garantir les heures de vie utile des luminaires installés dans des environnements où le dépassement de la température maximale de fonctionnement est possible et même probable. Grâce à des sondes thermiques, le luminaire connaît à tout moment sa température de fonctionnement.



CMR



CMR (CORA MANAGER READY) identifie les luminaires prilux compatibles avec le système CORA MANAGER qui fournit aux luminaires un contrôle de régulation et de programmation.



Cora Manager

la description



L'éclairage est l'un des éléments clés pour tracer la voie vers les villes intelligentes. Les systèmes de gestion de l'éclairage progressent à pas de géant, privilégiant des objectifs prioritaires tels que la qualité de service, la réduction des coûts et le respect de l'environnement. CORA Manager est le système de contrôle développé par Prilux qui, associé à nos luminaires compatibles qui permet une gestion intelligente de l'éclairage public, en maintenant l'harmonie entre le développement durable et la qualité de vie des citoyens, tout en favorisant la sécurité et l'économie.

Info



Pour plus d'informations sur les différentes solutions compatibles avec ce luminaire, consultez les codes BIDI suivants ou sur le web www.prilux.es