

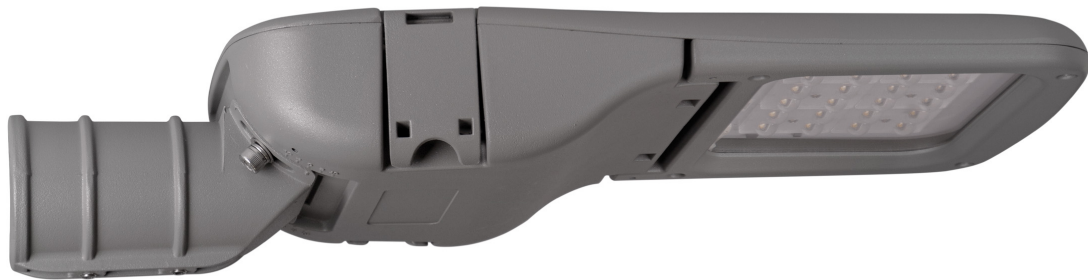

**MADE IN SPAIN**  
Design by PRILUX

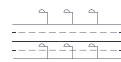

## Applications



Motorways



Roads



Cycle lanes



Parks



Viaducts



Pedestrian Zones



Residential Areas



Tunnels





















Car parks

## Certifications



## Specifications (Series luminaires)

	<b>Voltage (V)</b>	220-240V
Hz	<b>Frecuency (Hz)</b>	50-60Hz
	<b>Current (A)</b>	700mA
$\phi$	<b>Power factor (Cos fi)</b>	0.97
	<b>LED number</b>	12
	<b>Dimming</b>	8N - DALI
	<b>Comm. Prot. for reprogr.</b>	CMR
	<b>IP Tightness index</b>	IP66
	<b>IK Impact resistance</b>	IK10
	<b>Body color</b>	9007
	<b>Diffuser Material</b>	VT-T
	<b>Body</b>	AL iap
<b>K</b>	<b>Colour temperature</b>	4.000K
	<b>CRI Colour rendering index</b>	>70
	<b>Optical</b>	VA00K0M

	<b>Measures</b>	540x230x112mm
	<b>Wind Resistance</b>	0,124m2
	<b>Mounting</b>	Crosier Mount
	<b>Operating temperature</b>	-40~+50 °C
$\phi_{LUM}$	<b>Flux (lm)</b>	3.339lm
	<b>Electrical isolation</b>	CI
	<b>Lifetime</b>	L90 B10 >200.000h
$\phi/W$	<b>Efficacy</b>	126lm/W

Prilux guarantees a  $\pm 10\%$  tolerance in light flux measurements.

## Dimensions

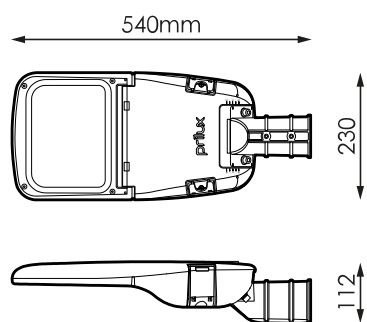

## References

	$W_{LED}$	W		$\phi$	$\phi_{LED}$	$\phi_{LUM}$	$\phi/W$		K
<b>570152</b>	24W	26,5W	700mA	4.437lm	4.072lm	3.339lm	126lm/W	12	4.000K

**Photometry**

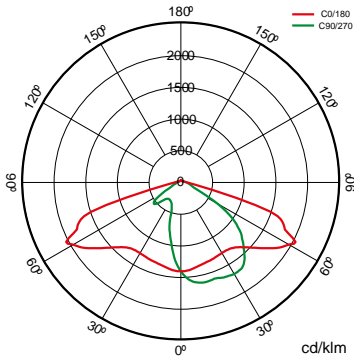

**On request**





Dali

---

Double Level with Line of Command



Class II



PC-T (IK10)



Available RAL colors (Consult)

---

50 °C (Consult available powers and optics)

- 
- PEXL0M
  - PPDL0M
  - PPIL0M
  - SI50L0M
  - VA00I0P
  - VA00L0M
  - VA01L0M
  - VA02L0M
  - VA03D0P
  - VA04D0P
  - VA05I0P
  - VA06I0P
  - VA07L0P
  - VA08L0M

- K**
- >70 2.700K
  - >80 3.000K
  - >80 4.000K
  - >70 2.700K



**Light packages**



			PCA	722	727	730	827	830	840
W			$\phi_{LUM}$ $\phi/W$	$\phi_{LUM}$ $\phi/W$	$\phi_{LUM}$ $\phi/W$	$\phi_{LUM}$ $\phi/W$	$\phi_{LUM}$ $\phi/W$	$\phi_{LUM}$ $\phi/W$	$\phi_{LUM}$ $\phi/W$
<b>26,5W</b>	12	700mA	1.600lm 60lm/W	2.440lm 92lm/W	2.896lm 109lm/W		2.598lm 98lm/W	2.598lm 98lm/W	2.738lm 103lm/W

**Mounting**

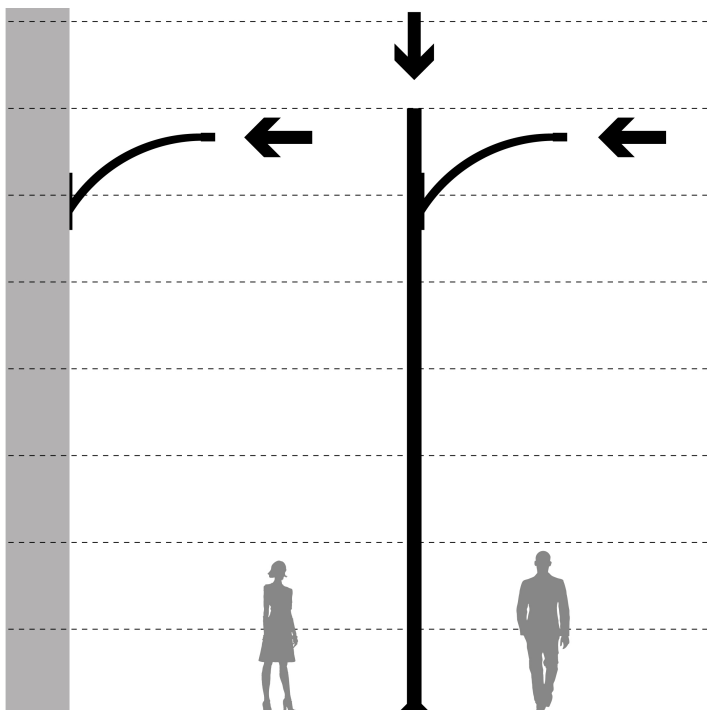

1. Crosier Mount

---

**Accessories**

---



---

**586566**

---

KIT ADAP. A POSTE  
Ø33MM VERSA-  
ARISA ROAD

---

**496636**

---

KIT ADAP. A POSTE  
Ø42MM VERSA-  
ARISA ROAD

---

**496629**

---

KIT ADAP. A POSTE  
Ø50MM VERSA-  
ARISA ROAD

---

**501743**

---

KIT ADAP. A POSTE  
Ø76MM  
POLIVALENTE TECN.  
RAL9007T



---

**Technologies**

---



---

**Overstorm**



OVERSTORM technology is designed for those luminaires that normally face electrically aggressive environments. It provides the product with three spheres of protection: In the outer sphere, an independent surge protector suppresses eventual voltage surges, in the intermediate sphere the drivers are prepared to withstand voltage peaks of up to 6 kV and 10kV. In the nuclear sphere, the protection in the LED module is provided both at its input, for small surges that have not been filtered by the external spheres.

---

---

**SystemShield**



SYSTEMSHIELD technology is designed to guarantee the hours of useful life of luminaires installed in environments where exceeding the maximum operating temperature is possible and even probable. Using thermal probes, the luminaire knows its operating temperature at all times.

---



---

**CMR**



CMR (CORA MANAGER READY) identifies the prilux luminaires compatible with the CORA MANAGER system that provides the luminaires with control, regulation and programming.

---



## Cora Manager

### description



One of the key pieces to achieve the path towards smart cities is lighting. Lighting management systems are advancing by leaps and bounds, prioritizing primary objectives such as service quality, cost reduction and care for the environment. CORA Manager is the control system developed by Prilux that, together with our compatible luminaires that provides intelligent management of public lighting, maintaining harmony between sustainable development and quality of life for citizens, while promoting safety and saving.

### Info



For more information on the different solutions compatible with this luminaire, consult the following BIDI codes or on the web [www.prilux.es](http://www.prilux.es)