

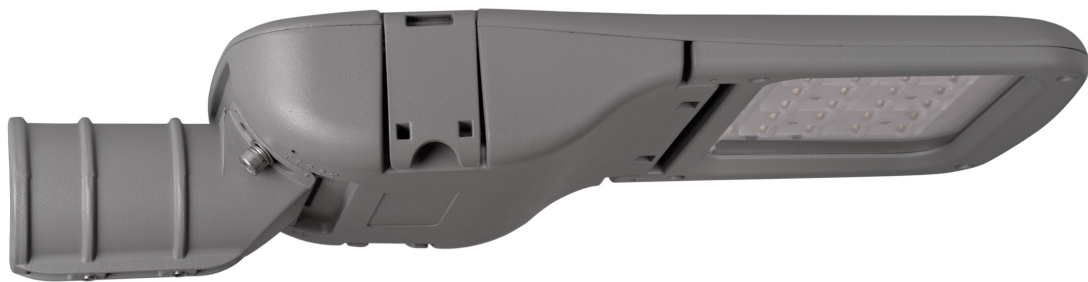

MADE IN SPAIN
Design by PRILUX

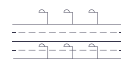

Applications



Motorways



Roads



Cycle lanes



Parks



Viaducts



Pedestrian Zones



Residential Areas



Tunnels





















Car parks

Certifications



Specifications (Series luminaires)

	Voltage (V)	220-240V
Hz	Frecuency (Hz)	50-60Hz
	Current (A)	350mA
ϕ	Power factor (Cos fi)	0.9
	LED number	24
	Dimming	8N - DALI
	Comm. Prot. for reprogr.	CMR
	IP Tightness index	IP66
	IK Impact resistance	IK10
	Body color	9007
	Diffuser Material	VT-T
	Body	AL iap
K	Colour temperature	3.000K
	CRI Colour rendering index	>70
	Optical	VA00K0M



	Measures	540x230x112mm
	Wind Resistance	0,124m2
	Mounting	Crosier Mount
	Operating temperature	-40~+50 °C
ϕ_{LUM}	Flux (lm)	3449lm
	Electrical isolation	CI
	Lifetime	L90 B10 >200.000h
ϕ/W	Efficacy	131lm/W

Prilux guarantees a $\pm 10\%$ tolerance in light flux measurements.

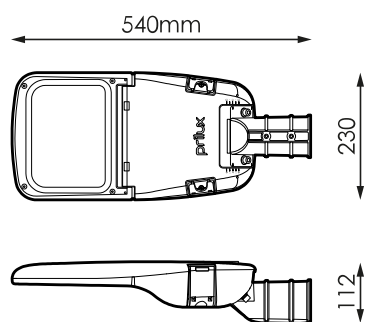
Dimensions



References

	W_{LED}	W		ϕ	ϕ_{LED}	ϕ_{LUM}	ϕ/W		K
570183	24W	26,4W	350mA	4585lm	3964lm	3449lm	131lm/W	24	3.000K

Photometry

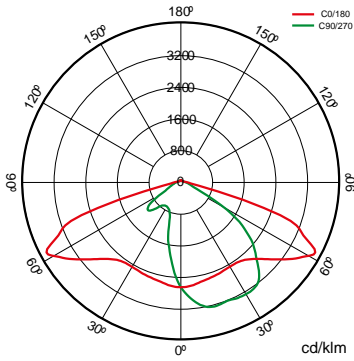

On request





Dali

Double Level with Line of Command



Class II



PC-T (IK10)



Available RAL colors (Consult)

50 °C (Consult available powers and optics)

- 
- PEXL0M
 - PPDL0M
 - PPILOM
 - SI50L0M
 - VA00I0P
 - VA00L0M
 - VA01L0M
 - VA02L0M
 - VA03D0P
 - VA04D0P
 - VA05I0P
 - VA06I0P
 - VA07L0P
 - VA08L0M

- K**
- >70 2.700K
 - >80 3.000K
 - >80 4.000K
 - >70 2.700K



Light packages



			PCA	722	727	730	827	830	840
W			ϕ_{LUM} ϕ/W	ϕ_{LUM} ϕ/W	ϕ_{LUM} ϕ/W	ϕ_{LUM} ϕ/W	ϕ_{LUM} ϕ/W	ϕ_{LUM} ϕ/W	ϕ_{LUM} ϕ/W
26,4W	24	350mA	1.812lm 69lm/W	2.614lm 99lm/W	3.102lm 118lm/W		2.782lm 105lm/W	2.782lm 105lm/W	2.932lm 111lm/W

Mounting

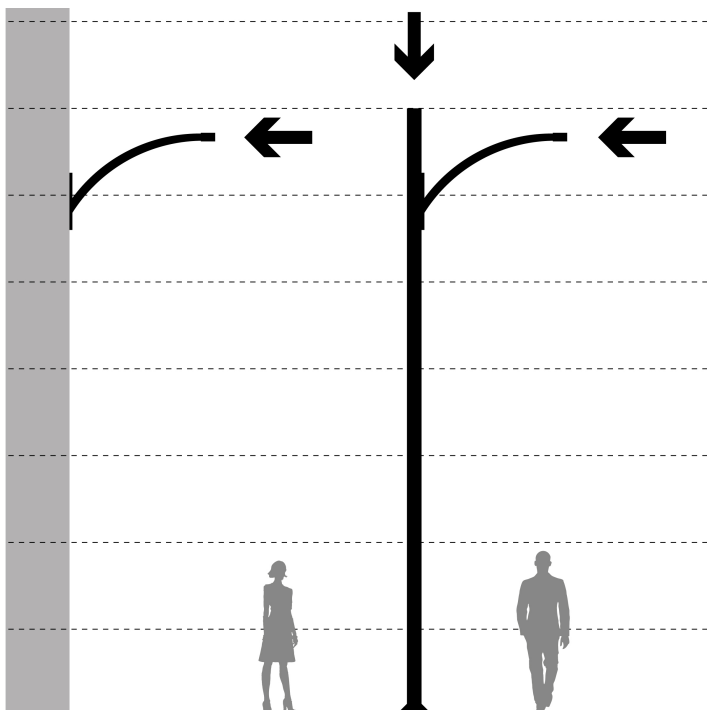

1. Crosier Mount

Accessories



586566

KIT ADAP. A POSTE
Ø33MM VERSA-
ARISA ROAD

496636

KIT ADAP. A POSTE
Ø42MM VERSA-
ARISA ROAD

496629

KIT ADAP. A POSTE
Ø50MM VERSA-
ARISA ROAD

501743

KIT ADAP. A POSTE
Ø76MM
POLIVALENTE TECN.
RAL9007T

Technologies



Overstorm



OVERSTORM technology is designed for those luminaires that normally face electrically aggressive environments. It provides the product with three spheres of protection: In the outer sphere, an independent surge protector suppresses eventual voltage surges, in the intermediate sphere the drivers are prepared to withstand voltage peaks of up to 6 kV and 10kV. In the nuclear sphere, the protection in the LED module is provided both at its input, for small surges that have not been filtered by the external spheres.

SystemShield



SYSTEMSHIELD technology is designed to guarantee the hours of useful life of luminaires installed in environments where exceeding the maximum operating temperature is possible and even probable. Using thermal probes, the luminaire knows its operating temperature at all times.



CMR



CMR (CORA MANAGER READY) identifies the prilux luminaires compatible with the CORA MANAGER system that provides the luminaires with control, regulation and programming.



Cora Manager

description



One of the key pieces to achieve the path towards smart cities is lighting. Lighting management systems are advancing by leaps and bounds, prioritizing primary objectives such as service quality, cost reduction and care for the environment. CORA Manager is the control system developed by Prilux that, together with our compatible luminaires that provides intelligent management of public lighting, maintaining harmony between sustainable development and quality of life for citizens, while promoting safety and saving.

Info



For more information on the different solutions compatible with this luminaire, consult the following BIDI codes or on the web www.prilux.es