

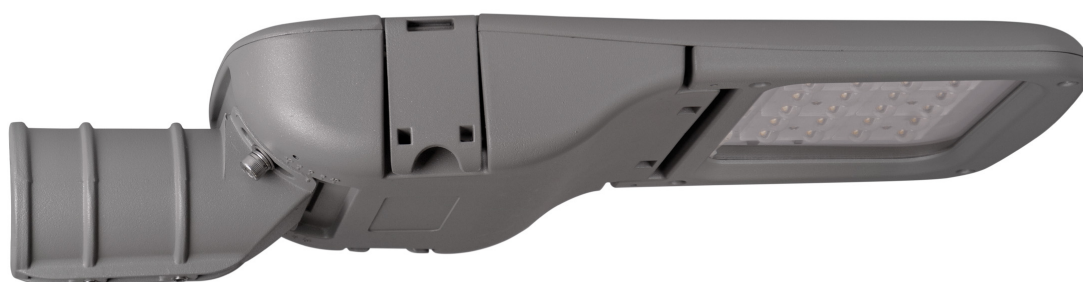

**MADE IN SPAIN**  
Design by PRILUX

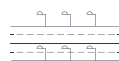

## Applications



Motorways

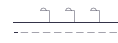

Roads



Cycle lanes



Parks



Viaducts



Pedestrian Zones



Residential Areas



Tunnels





















Car parks

## Certifications



## Specifications (Series luminaires)

	<b>Voltage (V)</b>	220-240V
Hz	<b>Frecuency (Hz)</b>	50-60Hz
	<b>Current (A)</b>	500mA
$\phi$	<b>Power factor (Cos fi)</b>	0.93
	<b>LED number</b>	24
	<b>Dimming</b>	8N - DALI
	<b>Comm. Prot. for reprogr.</b>	CMR
	<b>IP Tightness index</b>	IP66
	<b>IK Impact resistance</b>	IK10
	<b>Body color</b>	9007
	<b>Diffuser Material</b>	VT-T
	<b>Body</b>	AL iap
<b>K</b>	<b>Colour temperature</b>	3.000K
	<b>CRI Colour rendering index</b>	>70
	<b>Optical</b>	VA00K0M



	<b>Measures</b>	540x230x112mm
	<b>Wind Resistance</b>	0,124m2
	<b>Mounting</b>	Crosier Mount
	<b>Operating temperature</b>	-40~+50 °C
$\phi_{LUM}$	<b>Flux (lm)</b>	4740lm
	<b>Electrical isolation</b>	CI
	<b>Lifetime</b>	L90 B10 >200.000h
$\phi/W$	<b>Efficacy</b>	128lm/W

Prilux guarantees a  $\pm 10\%$  tolerance in light flux measurements.

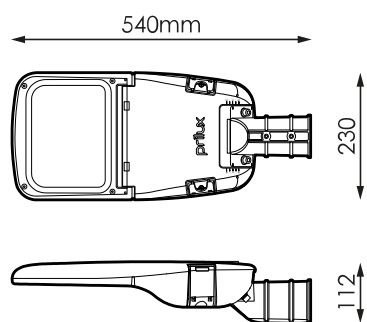
## Dimensions



## References

	$W_{LED}$	$W$		$\phi$	$\phi_{LED}$	$\phi_{LUM}$	$\phi/W$		<b>K</b>
<b>570206</b>	36W	37W	500mA	6.326lm	5.448lm	4740lm	128lm/W	24	3.000K

**Photometry**

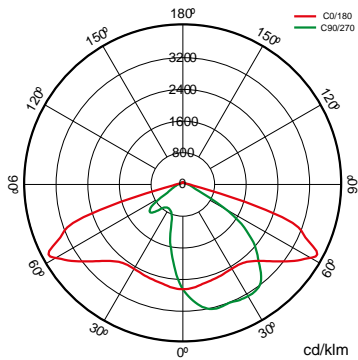

**On request**



Dali

Double Level with Line of Command

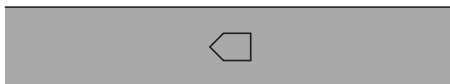

Class II



PC-T (IK10)



Available RAL colors (Consult)

50 °C (Consult available powers and optics)



PEXL0M

PPDL0M

PPILOM

SI50L0M

VA00I0P

VA00L0M

VA01L0M

VA02L0M

VA03D0P

VA04D0P

VA05I0P

VA06I0P

VA07L0P

VA08L0M



>70 2.700K



>80 3.000K

>80 4.000K

>70 2.700K

**Light packages**



			PCA	722	727	730	827	830	840
W			$\phi_{LUM}$ $\phi/W$	$\phi_{LUM}$ $\phi/W$	$\phi_{LUM}$ $\phi/W$	$\phi_{LUM}$ $\phi/W$	$\phi_{LUM}$ $\phi/W$	$\phi_{LUM}$ $\phi/W$	$\phi_{LUM}$ $\phi/W$
<b>37W</b>	24	500mA	2.427lm 66lm/W	3.592lm 97lm/W	4.263lm 115lm/W		3.824lm 103lm/W	3.824lm 103lm/W	4.030lm 109lm/W

**Mounting**

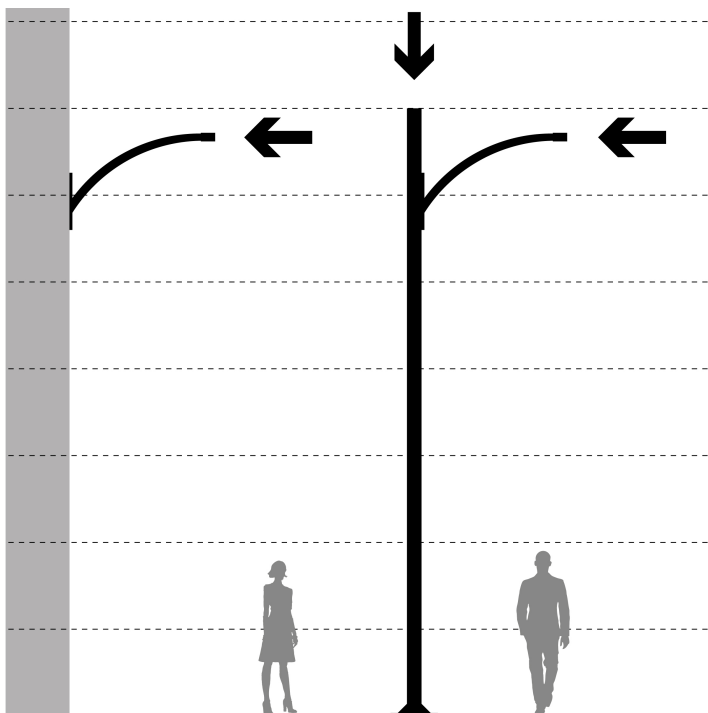

1. Crosier Mount

---

**Accessories**

---



---

**586566**

---

KIT ADAP. A POSTE  
Ø33MM VERSA-  
ARISA ROAD

---

**496636**

---

KIT ADAP. A POSTE  
Ø42MM VERSA-  
ARISA ROAD

---

**496629**

---

KIT ADAP. A POSTE  
Ø50MM VERSA-  
ARISA ROAD

---

**501743**

---

KIT ADAP. A POSTE  
Ø76MM  
POLIVALENTE TECN.  
RAL9007T



---

**Technologies**

---



---

**Overstorm**



OVERSTORM technology is designed for those luminaires that normally face electrically aggressive environments. It provides the product with three spheres of protection: In the outer sphere, an independent surge protector suppresses eventual voltage surges, in the intermediate sphere the drivers are prepared to withstand voltage peaks of up to 6 kV and 10kV. In the nuclear sphere, the protection in the LED module is provided both at its input, for small surges that have not been filtered by the external spheres.

---

---

**SystemShield**



SYSTEMSHIELD technology is designed to guarantee the hours of useful life of luminaires installed in environments where exceeding the maximum operating temperature is possible and even probable. Using thermal probes, the luminaire knows its operating temperature at all times.

---



---

**CMR**



CMR (CORA MANAGER READY) identifies the prilux luminaires compatible with the CORA MANAGER system that provides the luminaires with control, regulation and programming.

---



## **Cora Manager**

### **description**



One of the key pieces to achieve the path towards smart cities is lighting. Lighting management systems are advancing by leaps and bounds, prioritizing primary objectives such as service quality, cost reduction and care for the environment. CORA Manager is the control system developed by Prilux that, together with our compatible luminaires that provides intelligent management of public lighting, maintaining harmony between sustainable development and quality of life for citizens, while promoting safety and saving.

### **Info**



For more information on the different solutions compatible with this luminaire, consult the following BIDI codes or on the web [www.prilux.es](http://www.prilux.es)