

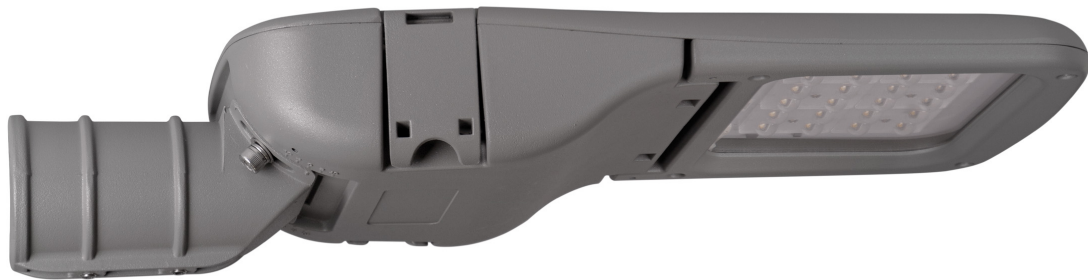

MADE IN SPAIN
Design by PRILUX

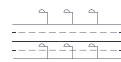

Aplicaciones



Autovías



Carreteras



Carril bici



Parques



Viaductos



Zonas Peatonales



Zonas Residenciales



Túneles







Parkings



Certificaciones



Especificaciones (Luminarias de Serie)









	Tensión (V)	220-240V
Hz	Frecuencia (Hz)	50-60Hz
	Intensidad (A)	500mA
ϕ	Factor de potencia (Cos fi)	0.93
	Número de leds	24
	Regulación	8N - DALI
	Prot. de com. para reprogr.	CMR

	Dimensiones	540x230x112mm
	Resistencia al Viento	0,124m2
	Montaje	Montaje en Báculo

	Temp. de funcionamiento	-40~+50 °C
---	--------------------------------	------------



ϕ_{LUM}	Flujo luminoso (lm)	4740lm
--------------	----------------------------	--------

	IP Índice de estanqueidad	IP66
	IK Protección contra impactos	IK10
	Color cuerpo	9007
	Difusor	VT-T
	Cuerpo	AL iap

	Aislamiento eléctrico	CI
---	------------------------------	----

	Vida útil	L90 B10 >200.000h
---	------------------	-------------------

ϕ/W	Eficacia	128lm/W
----------	-----------------	---------

K	Temperatura de color	3.000K
	CRI Índice de repr. cromática	>70
	Óptica	VA00K0M

Prilux garantiza una tolerancia $\pm 10\%$ en las medidas de flujo lumínico.

Dimensiones

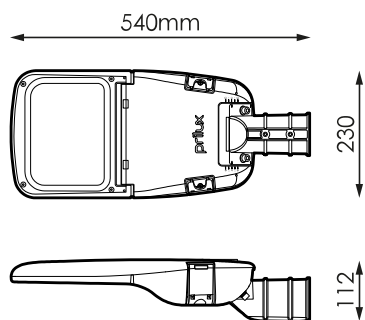

Referencias



	W_{LED}	W		ϕ	ϕ_{LED}	ϕ_{LUM}	ϕ/W		K
570206	36W	37W	500mA	6.326lm	5.448lm	4740lm	128lm/W	24	3.000K

Fotometría

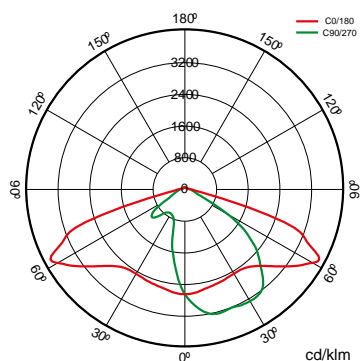

Bajo Pedido



DALI

Doble Nivel con Línea de Mando



Clase II



PC-T (IK10)



Disponible colores RAL (Consultar)

+50 °C (Consultar potencias y ópticas disponibles)



PEXL0M

PPDL0M

PPILOM

SI50L0M

VA00I0P

VA00L0M

VA01L0M

VA02L0M

VA03D0P

VA04D0P

VA05I0P

VA06I0P

VA07L0P

VA08L0M

K

>70 2.700K



>80 3.000K

>80 4.000K

>70 2.200K

Paquetes lumínicos



			PCA	722	727	730	827	830	840
W			ϕ_{LUM} ϕ/W	ϕ_{LUM} ϕ/W	ϕ_{LUM} ϕ/W	ϕ_{LUM} ϕ/W	ϕ_{LUM} ϕ/W	ϕ_{LUM} ϕ/W	ϕ_{LUM} ϕ/W
37W	24	500mA	2.427lm 66lm/W	3.592lm 97lm/W	4.263lm 115lm/W		3.824lm 103lm/W	3.824lm 103lm/W	4.030lm 109lm/W

Montaje



1. Montaje en Báculo

Accesorios



586566

KIT ADAP. A POSTE
Ø33MM VERSA-
ARISA ROAD

496636

KIT ADAP. A POSTE
Ø42MM VERSA-
ARISA ROAD

496629

KIT ADAP. A POSTE
Ø50MM VERSA-
ARISA ROAD

501743

KIT ADAP. A POSTE
Ø76MM
POLIVALENTE TECN.
RAL9007T



Tecnologías



Overstorm



La tecnología OVERSTORM está pensada para aquellas luminarias que normalmente se enfrentan a entornos eléctricamente agresivos. Dota al producto de tres esferas de protección: En la esfera exterior un protector contra sobretensiones independiente suprime las eventuales subidas de tensión, la esfera intermedia los drivers están preparados para soportar picos de tensión de hasta 6 kV y 10kV. En la esfera nuclear la protección en el módulo LED se proporciona tanto en su entrada, para las pequeñas sobretensiones que no han sido filtradas por las esferas externas.

SystemShield



La tecnología SYSTEMSHIELD está pensada para garantizar las horas de vida útil de luminarias instaladas en entornos en los que superar la temperatura máxima de operación es posible e incluso probable. Mediante sondas térmicas la luminaria conoce en todo momento su temperatura de funcionamiento.



CMR



CMR (CORA MANAGER READY) identifica a las luminarias de prilux compatibles con el sistema CORA MANAGER que dota a las luminarias de control regulación y programación.



Cora Manager

descripción



La iluminación es clave para ciudades inteligentes. Los sistemas de gestión de alumbrado avanzan rápidamente con enfoque en calidad, reducción de costes y cuidado ambiental. CORA Manager de Prilux, junto con nuestras luminarias, ofrece gestión inteligente de alumbrado público para desarrollo sostenible, calidad de vida, seguridad y ahorro.

Info



Para obtener más información de las diferentes soluciones compatibles con esta luminaria consulte en los siguientes códigos BIDI o en la web www.prilux.es