

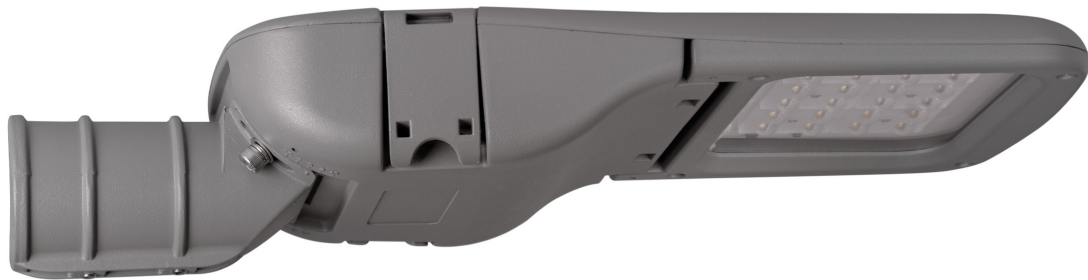

MADE IN SPAIN
Design by PRILUX

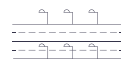

Applications



Autoroutes



Routes



Pistes cyclables



Parcs



Viaducs



Zones piétonnes



Zones résidentielles



Tunnels





















Parkings

Certifications



Spécifications (Luminaires de la série)

| | | |
|--|---|-----------|
|  | Tension D` Alimentation (V) | 220-240V |
| Hz | Fréquence (Hz) | 50-60Hz |
|  | Intensité (A) | 500mA |
| ϕ | Facteur de puissance (Cos fi) | 0.93 |
|  | Nombre de led | 24 |
|  | Atténuation | 8N - DALI |
|  | Prot. de comm. pour reprogr. | CMR |
|  | Indice d'étanchéité IP | IP66 |
|  | IK Protection contre des impacts | IK10 |
|  | Couleur du corps | 9007 |
|  | Matériau du diffuseur | VT-T |
|  | Corps | AL iap |
| K | Température de couleur | 4.000K |
|  | CRI Indice de rendu des couleurs | >70 |
|  | Optique | VA00K0M |



| | | |
|---|-------------------------------|-------------------|
|  | Dimensions | 540x230x112mm |
|  | Résistance au vent | 0,124m2 |
|  | L'assemblée | Monture en crose |
|  | Température de service | -40~+50 °C |
| ϕ_{LUM} | Flux (lm) | 4.901lm |
|  | Isolation électrique | CI |
|  | Heures de vie | L90 B10 >200.000h |
| ϕ/W | Efficacité | 132lm/W |

Prilux garantit une tolérance de $\pm 10\%$ dans les mesures de flux lumineux.

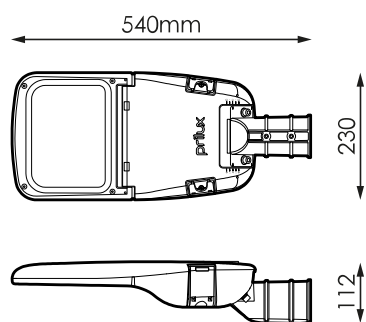
Dimensions



Les références

| | | | | | | | | | |
|---|-----------|-----|---|---------|--------------|--------------|----------|---|----------|
|  | W_{LED} | W |  | ϕ | ϕ_{LED} | ϕ_{LUM} | ϕ/W |  | K |
| 570213 | 36W | 37W | 500mA | 6.621lm | 5.633lm | 4.901lm | 132lm/W | 24 | 4.000K |

Photométrie

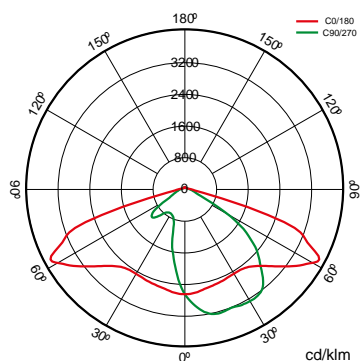

Sur demande



Dali

Double niveau avec ligne de commande



Classe II



PC-T (IK10)



Couleurs RAL disponibles (Consulter)

50 °C (Consulter les puissances et optiques disponibles)



PEXL0M

PPDL0M

PPIL0M

SI50L0M

VA00I0P

VA00L0M

VA01L0M

VA02L0M

VA03D0P

VA04D0P

VA05I0P

VA06I0P

VA07L0P

VA08L0M

K

>70 2.700K



>80 3.000K

>80 4.000K

>70 2.700K

Forfaits légers



| | | | PCA | 722 | 727 | 730 | 827 | 830 | 840 |
|------------|---|---|-----------------------|-----------------------|-----------------------|-----------------------|-----------------------|-----------------------|-----------------------|
| W |  |  | ϕ_{LUM} ϕ/W | ϕ_{LUM} ϕ/W | ϕ_{LUM} ϕ/W | ϕ_{LUM} ϕ/W | ϕ_{LUM} ϕ/W | ϕ_{LUM} ϕ/W | ϕ_{LUM} ϕ/W |
| 37W | 24 | 500mA | 2.427lm 66lm/W | 3.592lm 97lm/W | 4.263lm 115lm/W | | 3.824lm 103lm/W | 3.824lm 103lm/W | 4.030lm 109lm/W |

Montage

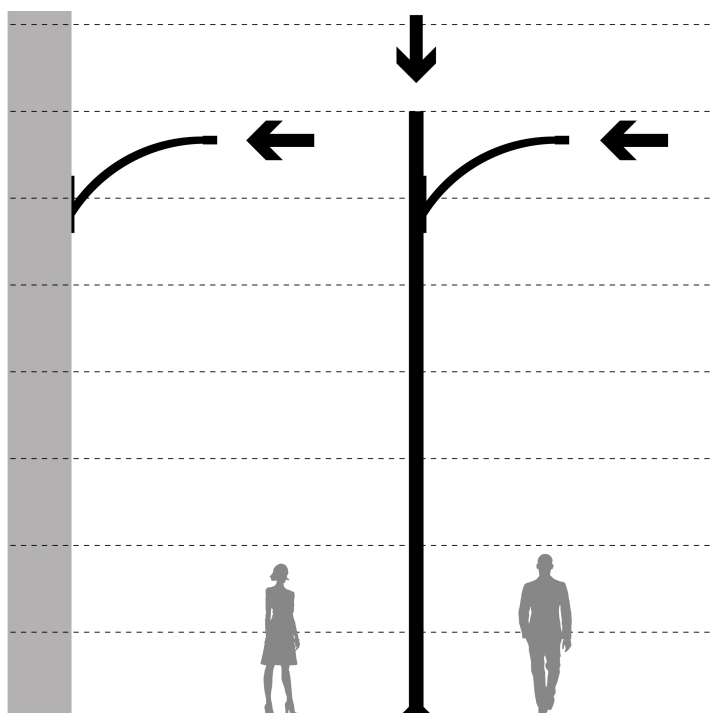

1. Monture en crosse

Accessoires



586566

KIT ADAPT. POUR
MAT DE Ø33MM
VERSA-ARISA ROAD

496636

KIT ADAPT. POUR
MAT DE Ø42MM
VERSA-ARISA ROAD

496629

KIT ADAPT. POUR
MAT DE Ø50MM
VERSA-ARISA ROAD

501743

KIT ADAPT. POUR
MAT DE Ø76MM
POLIVALENT POUR
LANTERNES
ECLAIRAGE ROUTIER
RAL9007T



Les technologies



Overstorm



La technologie OVERSTORM est conçue pour les luminaires qui font normalement face à des environnements électriquement agressifs. Il fournit au produit trois sphères de protection : dans la sphère externe, un parasurtenseur indépendant supprime les surtensions éventuelles, dans la sphère intermédiaire, les pilotes sont préparés pour résister à des pics de tension allant jusqu'à 6 kV et 10 kV. Dans la sphère nucléaire, la protection dans le module LED est assurée aussi bien à son entrée, que pour les petites surtensions qui n'ont pas été filtrées par les sphères extérieures.

SystemShield



La technologie SYSTEMSHIELD est conçue pour garantir les heures de vie utile des luminaires installés dans des environnements où le dépassement de la température maximale de fonctionnement est possible et même probable. Grâce à des sondes thermiques, le luminaire connaît à tout moment sa température de fonctionnement.



CMR



CMR (CORA MANAGER READY) identifie les luminaires prilux compatibles avec le système CORA MANAGER qui fournit aux luminaires un contrôle de régulation et de programmation.



Cora Manager

la description

L'éclairage est l'un des éléments clés pour tracer la voie vers les villes intelligentes. Les systèmes de gestion de l'éclairage progressent à pas de géant, privilégiant des objectifs prioritaires tels que la qualité de service, la réduction des coûts et le respect de l'environnement. CORA Manager est le système de contrôle développé par Prilux qui, associé à nos luminaires compatibles qui permet une gestion intelligente de l'éclairage public, en maintenant l'harmonie entre le développement durable et la qualité de vie des citoyens, tout en favorisant la sécurité et l'économie.

Info

Pour plus d'informations sur les différentes solutions compatibles avec ce luminaire, consultez les codes BIDI suivants ou sur le web www.prilux.es