

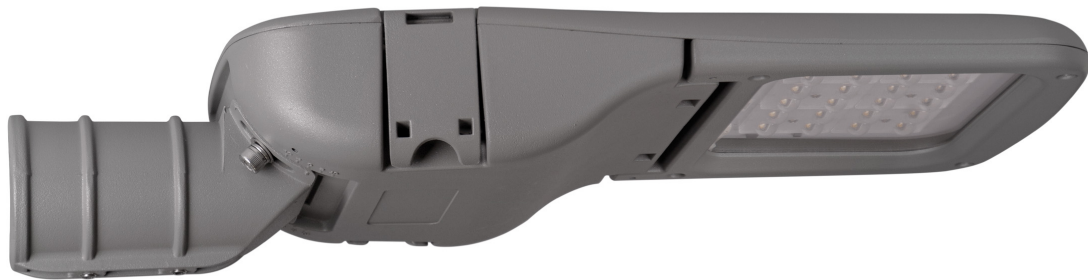

**MADE IN SPAIN**  
Design by PRILUX

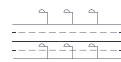

**Aplicaciones**



Autovías



Carreteras



Carril bici



Parques



Viaductos



Zonas Peatonales



Zonas Residenciales



Túneles







Parkings



**Certificaciones**



## Especificaciones (Luminarias de Serie)









	<b>Tensión (V)</b>	220-240V
Hz	<b>Frecuencia (Hz)</b>	50-60Hz
	<b>Intensidad (A)</b>	1.000mA
$\phi$	<b>Factor de potencia (Cos fi)</b>	0.97
	<b>Número de leds</b>	24
	<b>Regulación</b>	8N - DALI
	<b>Prot. de com. para reprogr.</b>	CMR

	<b>Dimensiones</b>	540x230x112mm
	<b>Resistencia al Viento</b>	0,124m2
	<b>Montaje</b>	Montaje en Báculo

	<b>Temp. de funcionamiento</b>	-40~+35 °C
---	--------------------------------	------------



$\phi_{LUM}$	<b>Flujo luminoso (lm)</b>	8299lm
--------------	----------------------------	--------

	<b>IP Índice de estanqueidad</b>	IP66
	<b>IK Protección contra impactos</b>	IK10
	<b>Color cuerpo</b>	9007
	<b>Difusor</b>	VT-T
	<b>Cuerpo</b>	AL iap

	<b>Aislamiento eléctrico</b>	CI
---	------------------------------	----

	<b>Vida útil</b>	L90 B10 >200.000h
---	------------------	-------------------

$\phi/W$	<b>Eficacia</b>	111lm/W
----------	-----------------	---------

K	<b>Temperatura de color</b>	3.000K
	<b>CRI Índice de repr. cromática</b>	>70
	<b>Óptica</b>	VA00K0M

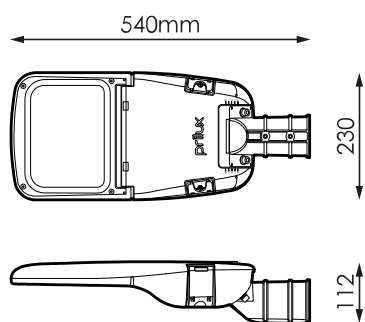

Prilux garantiza una tolerancia  $\pm 10\%$  en las medidas de flujo lumínico.

## Dimensiones



## Referencias



	$W_{LED}$	W		$\phi$	$\phi_{LED}$	$\phi_{LUM}$	$\phi/W$		K
<b>570244</b>	72W	74,6W	1000mA	11.400lm	9.539lm	8299lm	111lm/W	24	3.000K

## Fotometría

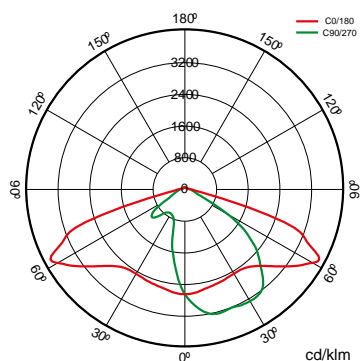

## Bajo Pedido



DALI

Doble Nivel con Línea de Mando



Clase II



PC-T (IK10)



Disponible colores RAL (Consultar)

+50 °C (Consultar potencias y ópticas disponibles)



PEXL0M

PPDL0M

PPILOM

S150L0M

VA00I0P

VA00L0M

VA01L0M

VA02L0M

VA03D0P

VA04D0P

VA05I0P

VA06I0P

VA07L0P

VA08L0M

K

>70 2.700K



>80 3.000K

>80 4.000K

>70 2.200K

**Paquetes lumínicos**



			PCA	722	727	730	827	830	840
W			$\phi_{LUM}$ $\phi/W$	$\phi_{LUM}$ $\phi/W$	$\phi_{LUM}$ $\phi/W$	$\phi_{LUM}$ $\phi/W$	$\phi_{LUM}$ $\phi/W$	$\phi_{LUM}$ $\phi/W$	$\phi_{LUM}$ $\phi/W$
<b>74,6W</b>	24	1.000mA		6.287lm 84lm/W	5.656lm 109lm/W		6.695lm 90lm/W	6.695lm 90lm/W	5.349lm 103lm/W

**Montaje**

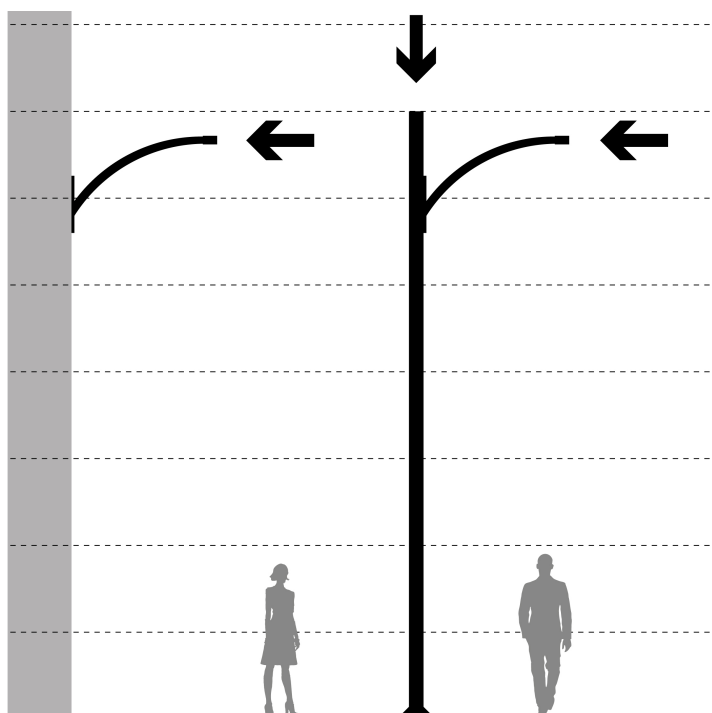

1. Montaje en Báculo

---

**Accesorios**

---



---

**586566**

---

KIT ADAP. A POSTE  
Ø33MM VERSA-  
ARISA ROAD

---

**496636**

---

KIT ADAP. A POSTE  
Ø42MM VERSA-  
ARISA ROAD

---

**496629**

---

KIT ADAP. A POSTE  
Ø50MM VERSA-  
ARISA ROAD

---

**501743**

---

KIT ADAP. A POSTE  
Ø76MM  
POLIVALENTE TECN.  
RAL9007T



---

**Tecnologías**

---



---

**Overstorm**

---



La tecnología OVERSTORM está pensada para aquellas luminarias que normalmente se enfrentan a entornos eléctricamente agresivos. Dota al producto de tres esferas de protección: En la esfera exterior un protector contra sobretensiones independiente suprime las eventuales subidas de tensión, la esfera intermedia los drivers están preparados para soportar picos de tensión de hasta 6 kV y 10kV. En la esfera nuclear la protección en el módulo LED se proporciona tanto en su entrada, para las pequeñas sobretensiones que no han sido filtradas por las esferas externas.

---

---

**SystemShield**

---



La tecnología SYSTEMSHIELD está pensada para garantizar las horas de vida útil de luminarias instaladas en entornos en los que superar la temperatura máxima de operación es posible e incluso probable. Mediante sondas térmicas la luminaria conoce en todo momento su temperatura de funcionamiento.

---



---

**CMR**

---



CMR (CORA MANAGER READY) identifica a las luminarias de prilux compatibles con el sistema CORA MANAGER que dota a las luminarias de control regulación y programación.

---



## Cora Manager

### descripción

La iluminación es clave para ciudades inteligentes. Los sistemas de gestión de alumbrado avanzan rápidamente con enfoque en calidad, reducción de costes y cuidado ambiental. CORA Manager de Prilux, junto con nuestras luminarias, ofrece gestión inteligente de alumbrado público para desarrollo sostenible, calidad de vida, seguridad y ahorro.

### Info

Para obtener más información de las diferentes soluciones compatibles con esta luminaria consulte en los siguientes códigos BIDI o en la web [www.prilux.es](http://www.prilux.es)