

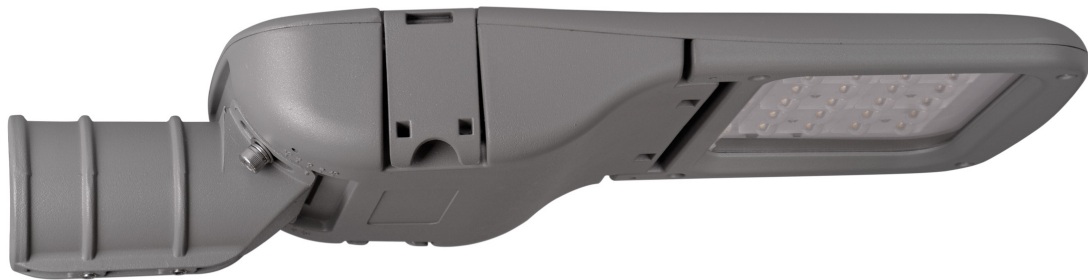

MADE IN SPAIN
Design by PRILUX



Certificações



Formulários

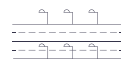

Auto-estradas



Estradas



Faixas para



Parques



Viadutos



Zonas pedonais



Áreas Residenciais



Túneis



Estacionamentos



Especificações (Luminárias da série)



	Tensão (V)	220-240V
Hz	Frequência (Hz)	50-60Hz
	Intensidade (A)	1.000mA
ϕ	Fator de Potência (Cos fi)	0.97
	Número de leds	24
	Regulação	Não
	Índice de estanqueidade IP	IP66
	IK Proteção contra impactos	IK08
	Material Difusor	VT-T 6mm
	Corpo	AL iap
K	Temperatura de cor	4000K
	CRI Índice de repr. cromática	70cromatica
	Óptica	VA00KOM

	Dimensão	540x230x112mm
	Resistência ao vento	0,124m2
	Assembly	Monte Crúzio
	Temperatura de trabalho	35°C
ϕ_{LUM}	Fluxo (lm)	8580lm
	Isolamento elétrico	CCI
	Vida	L90B10>200000h
	Vida	L90 B10 >200.000h
ϕ/W	Eficácia	115lm/W

Prilux garante uma tolerância de $\pm 10\%$ nas medições de fluxo de luz.

Dimensões

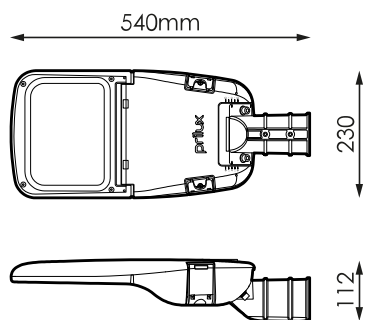

Referências



	W_{LED}	W		ϕ	ϕ_{LED}	ϕ_{LUM}	ϕ/W		K
570251	72W	74,6W	1000mA	11930lm	9862lm	8580lm	115lm/W	24	4000K

Fotometria

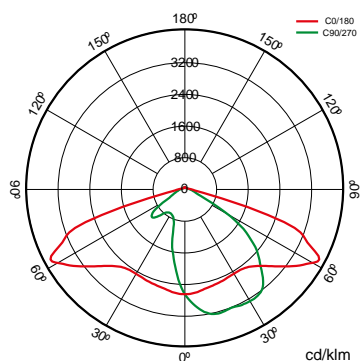

A pedido



Dali

Nível duplo com linha de comando



Classe II



PC-T (IK10)



Cores RAL disponíveis (Consultar)

50 °C (Consulte potências e óticas disponíveis)

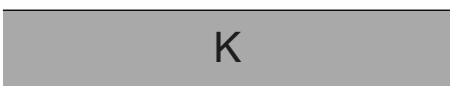

>70 2.700K

>80 3.000K

>80 4.000K

>70 2.700K



PEXL0M

PPDL0M

PPIL0M

SI50L0M

VA00I0P

VA00L0M

VA01L0M

VA02L0M

VA03D0P

VA04D0P

VA05I0P



VA06I0P

VA07L0P

VA08L0M

Pacotes leves



			PCA	722	727	730	827	830	840
W			ϕ_{LUM} ϕ/W	ϕ_{LUM} ϕ/W	ϕ_{LUM} ϕ/W	ϕ_{LUM} ϕ/W	ϕ_{LUM} ϕ/W	ϕ_{LUM} ϕ/W	ϕ_{LUM} ϕ/W
74,6W	24	1.000mA		6.287lm 84lm/W	5.656lm 109lm/W		6.695lm 90lm/W	6.695lm 90lm/W	5.349lm 103lm/W

Montagem



1. Monte Crúzio

Acessórios



586566

KIT ADAP. A POSTE
Ø33MM VERSA-
ARISA ROAD

496636

KIT ADAP. A POSTE
Ø42MM VERSA-
ARISA ROAD

496629

KIT ADAP. A POSTE
Ø50MM VERSA-
ARISA ROAD

501743

KIT ADAP. A POSTE
Ø76MM
POLIVALENTE TECN.
RAL9007T



Tecnologias



Overstorm



A tecnologia OVERSTORM foi projetada para as luminárias que normalmente enfrentam ambientes eletricamente agressivos. Fornece ao produto três esferas de proteção: Na esfera externa, um estabilizador independente suprime eventuais picos de tensão, na esfera intermediária os drivers são preparados para suportar picos de tensão de até 6 kV e 10 kV. Na esfera nuclear, a proteção no módulo de LED é fornecida tanto na sua entrada, para pequenos surtos que não foram filtrados pelas esferas externas.

SystemShield



A tecnologia SYSTEMSHIELD foi concebida para garantir as horas de vida útil das luminárias instaladas em ambientes onde ultrapassar a temperatura máxima de funcionamento é possível e mesmo provável. Usando sondas térmicas, a luminária sabe sua temperatura operacional em todos os momentos.



CMR



O CMR (CORA MANAGER READY) identifica as luminárias prilux compatíveis com o sistema CORA MANAGER que fornece às luminárias o controle de regulação e programação.

Regras



Níveis programables



Cora Gerente

descrição



Gestão da iluminação no quadro elétrico que permite o controlo em grupo das luminárias ligadas ao centro de controlo através da linha de alimentação (CMR) sem cablagem adicional

Informacje



Para mais informações sobre as diferentes soluções compatíveis com esta luminária, consulte os seguintes códigos BIDI ou na web www.prilux.es