

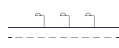

MADE IN SPAIN
Design by PRILUX



Applications



Roads



Residential Areas



Pedestrian Zones











Certifications









Car parks



Specifications (Series luminaires)

	Voltage (V)	220-240V
Hz	Frecuency (Hz)	50-60Hz
	Current (A)	500mA
ϕ	Power factor (Cos fi)	0.94
	LED number	12
	Dimming	8N - DALI
	Comm. Prot. for reprogr.	CMR
	IP Tightness index	IP65
	IK Impact resistance	IK08
	Diffuser Material	PC-T
	Body	AL iap
K	Colour temperature	4.000K
	CRI Colour rendering index	>70
	Optical	VA00LIM



	Measures	Ø600x655mm
	Weight	10Kg
	Wind Resistance	0,282m2
	Mounting	Arm Mount
	Operating temperature	-40~+35°C
ϕ_{LUM}	Flux (lm)	2.721lm
	Electrical isolation	CI
	Lifetime	L90 B10 >200.000h
ϕ/W	Efficacy	145lm/W

Prilux guarantees a $\pm 10\%$ tolerance in light flux measurements.

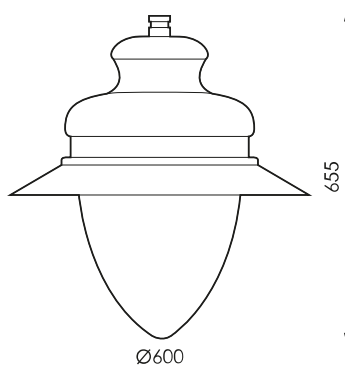
Dimensions



References

	W_{LED}	W		ϕ	ϕ_{LED}	ϕ_{LUM}	ϕ/W		K
572200	18W	18,8W	500mA	3.310lm	3.278lm	2.721lm	145lm/W	12	4.000K

Photometry

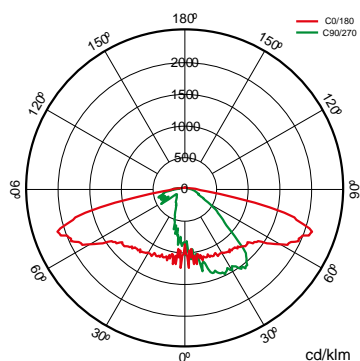

On request



Dali

Double Level with Line of Command

K

PCAmbar

>70 2.700K

>80 3.000K

>80 4.000K



Available RAL colors (Consult)





S150LOM

S150LIM

Light packages



			PCA	722	727	730	827	830	840
W			ϕ_{LUM} ϕ/W	ϕ_{LUM} ϕ/W	ϕ_{LUM} ϕ/W	ϕ_{LUM} ϕ/W	ϕ_{LUM} ϕ/W	ϕ_{LUM} ϕ/W	ϕ_{LUM} ϕ/W
18,8W	12	500mA	1,42lm 76lm/W	2.101lm 112lm/W	2,479lm 132lm/W	2.600lm 138lm/W	2,238lm 119lm/W	2,238lm 119lm/W	2,358lm 125lm/W

Mounting

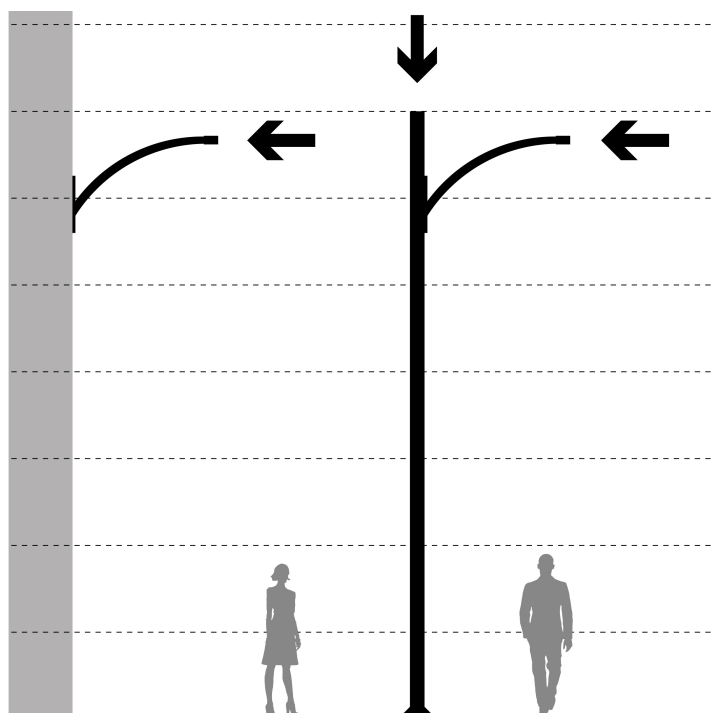

1. Arm Mount

Technologies



Overstorm



OVERSTORM technology is designed for those luminaires that normally face electrically aggressive environments. It provides the product with three spheres of protection: In the outer sphere, an independent surge protector suppresses eventual voltage surges, in the intermediate sphere the drivers are prepared to withstand voltage peaks of up to 6 kV and 10kV. In the nuclear sphere, the protection in the LED module is provided both at its input, for small surges that have not been filtered by the external spheres.

SystemShield



SYSTEMSHIELD technology is designed to guarantee the hours of useful life of luminaires installed in environments where exceeding the maximum operating temperature is possible and even probable. Using thermal probes, the luminaire knows its operating temperature at all times.



CMR



CMR (CORA MANAGER READY) identifies the prilux luminaires compatible with the CORA MANAGER system that provides the luminaires with control, regulation and programming.



Cora Manager

description



One of the key pieces to achieve the path towards smart cities is lighting. Lighting management systems are advancing by leaps and bounds, prioritizing primary objectives such as service quality, cost reduction and care for the environment. CORA Manager is the control system developed by Prilux that, together with our compatible luminaires that provides intelligent management of public lighting, maintaining harmony between sustainable development and quality of life for citizens, while promoting safety and saving.

Info



For more information on the different solutions compatible with this luminaire, consult the following BIDI codes or on the web www.prilux.es

Info



Includes Optical Group with ENAC tests and ENEC, CB, N certification