



MADE IN SPAIN
Design by PRILUX



Aplicaciones



Carreteras



Zonas Residenciales



Zonas Peatonales











Certificaciones



Parkings



Especificaciones (Luminarias de Serie)

	Tensión (V)	220-240V
Hz	Frecuencia (Hz)	50-60Hz
	Intensidad (A)	350mA
ϕ	Factor de potencia (Cos fi)	0.91
	Número de leds	32
	Regulación	8N - DALI
	Prot. de com. para reprogr.	CMR
	IP Índice de estanqueidad	IP65
	IK Protección contra impactos	IK08
	Difusor	PC-T + VT-E 4mm
	Cuerpo	AL iap
K	Temperatura de color	4.000K
	CRI Índice de repr. cromática	>70
	Óptica	VA00K0M



	Dimensiones	Ø600x655mm
	Peso	10Kg
	Resistencia al Viento	0,282m2
	Montaje	Montaje en Brazo
	Temp. de funcionamiento	-40~+35°C
ϕ_{LUM}	Flujo luminoso (lm)	4.216lm
	Aislamiento eléctrico	CI
	Vida útil	L90 B10 >200.000h
ϕ/W	Eficacia	123lm/W

Prilux garantiza una tolerancia $\pm 10\%$ en las medidas de flujo lumínico.

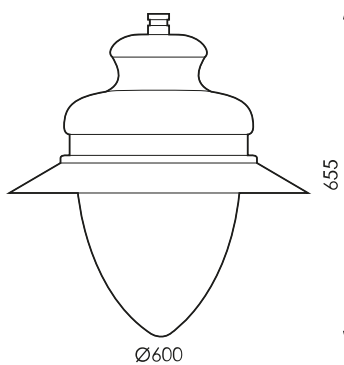
Dimensiones



Referencias

	W_{LED}	W		ϕ	ϕ_{LED}	ϕ_{LUM}	ϕ/W		K
572248	32W	34,3W	350mA	6.397lm	6.023lm	4.216lm	123lm/W	32	4.000K

Fotometría

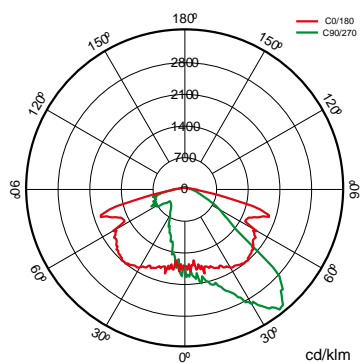

Bajo Pedido



DALI

Doble Nivel con Línea de Mando

K

PC Ambar

>70 2.700K

>80 3.000K

>80 4.000K



Disponible colores RAL (Consultar)





S150L0M

S150L1M

Paquetes lumínicos



			PCA	722	727	730	827	830	840
W			ϕ_{LUM} ϕ/W	ϕ_{LUM} ϕ/W	ϕ_{LUM} ϕ/W	ϕ_{LUM} ϕ/W	ϕ_{LUM} ϕ/W	ϕ_{LUM} ϕ/W	ϕ_{LUM} ϕ/W
34,3W	32	350mA	2,257lm 66lm/W	3,256lm 95lm/W	3,842lm 112lm/W	4,029lm 117lm/W	3,467lm 101lm/W	3,467lm 101lm/W	3,654lm 107lm/W

Montaje

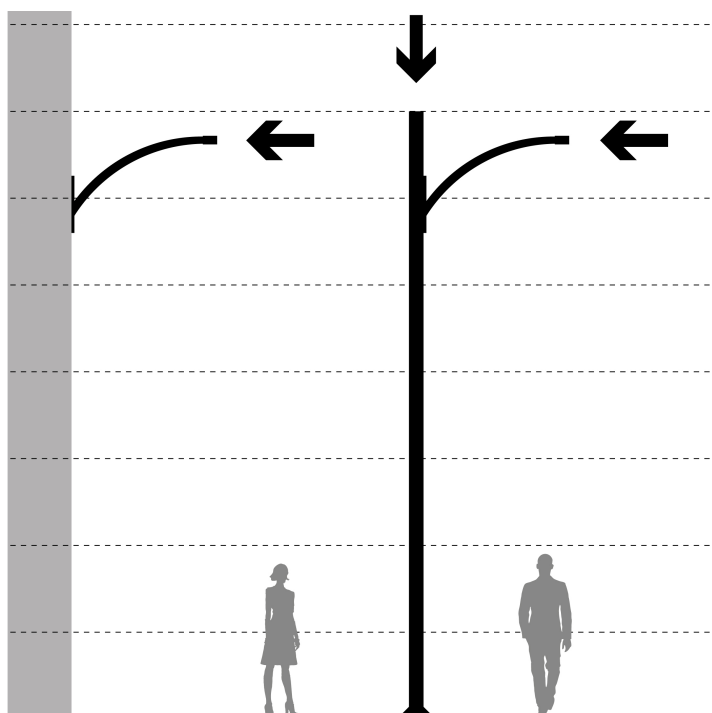

1. Montaje en Brazo



Tecnologías



Overstorm



La tecnología OVERSTORM está pensada para aquellas luminarias que normalmente se enfrentan a entornos eléctricamente agresivos. Dota al producto de tres esferas de protección: En la esfera exterior un protector contra sobretensiones independiente suprime las eventuales subidas de tensión, la esfera intermedia los drivers están preparados para soportar picos de tensión de hasta 6 kV y 10kV. En la esfera nuclear la protección en el módulo LED se proporciona tanto en su entrada, para las pequeñas sobretensiones que no han sido filtradas por las esferas externas.

SystemShield



La tecnología SYSTEMSHIELD está pensada para garantizar las horas de vida útil de luminarias instaladas en entornos en los que superar la temperatura máxima de operación es posible e incluso probable. Mediante sondas térmicas la luminaria conoce en todo momento su temperatura de funcionamiento.



CMR



CMR (CORA MANAGER READY) identifica a las luminarias de prilux compatibles con el sistema CORA MANAGER que dota a las luminarias de control regulación y programación.



Cora Manager

descripción



La iluminación es clave para ciudades inteligentes. Los sistemas de gestión de alumbrado avanzan rápidamente con enfoque en calidad, reducción de costes y cuidado ambiental. CORA Manager de Prilux, junto con nuestras luminarias, ofrece gestión inteligente de alumbrado público para desarrollo sostenible, calidad de vida, seguridad y ahorro.

Info



Para obtener más información de las diferentes soluciones compatibles con esta luminaria consulte en los siguientes códigos BIDI o en la web www.prilux.es

Info



Incluye Grupo Óptico con ensayos ENAC y certificación ENEC ,CB, N