

MADE IN SPAIN
Design by PRILUX

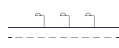

Applications



Roads



Residential Areas



Pedestrian Zones











Certifications









Car parks



Specifications (Series luminaires)

| | | |
|--|-----------------------------------|-----------------|
|  | Voltage (V) | 220-240V |
| Hz | Frecuency (Hz) | 50-60Hz |
|  | Current (A) | 500mA |
| ϕ | Power factor (Cos fi) | 0.95 |
|  | LED number | 32 |
|  | Dimming | 8N - DALI |
|  | Comm. Prot. for reprogr. | CMR |
|  | IP Tightness index | IP65 |
|  | IK Impact resistance | IK08 |
|  | Diffuser Material | PC-T + VT-E 4mm |
|  | Body | AL iap |
| K | Colour temperature | 4.000K |
|  | CRI Colour rendering index | >70 |
|  | Optical | VA00K0M |

| | | |
|--|------------------------------|-------------------|
|  | Measures | Ø600x655mm |
|  | Weight | 10Kg |
|  | Wind Resistance | 0,282m2 |
|  | Mounting | Arm Mount |
|  | Operating temperature | -40~+35°C |
| ϕ_{LUM} | Flux (lm) | 5.892lm |
|  | Electrical isolation | CI |
|  | Lifetime | L90 B10 >200.000h |
| ϕ/W | Efficacy | 120lm/W |

Prilux guarantees a $\pm 10\%$ tolerance in light flux measurements.

Dimensions

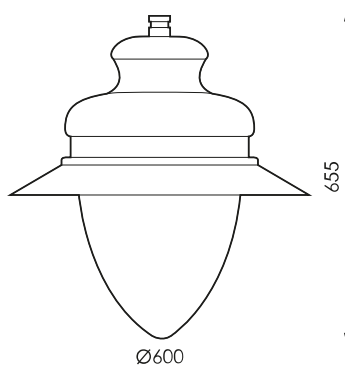

References

| | | | | | | | | | |
|---|-----------|-------|---|---------|--------------|--------------|----------|---|--------|
|  | W_{LED} | W |  | ϕ | ϕ_{LED} | ϕ_{LUM} | ϕ/W |  | K |
| 572255 | 48W | 49,2W | 500mA | 8.828lm | 8.417lm | 5.892lm | 120lm/W | 32 | 4.000K |

Photometry

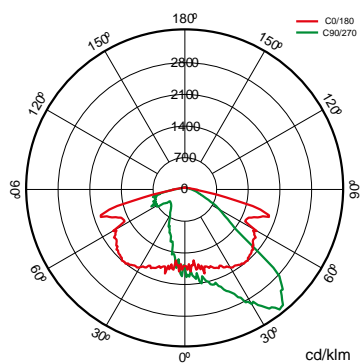

On request



Dali

Double Level with Line of Command

K

PCAmbar

>70 2.700K

>80 3.000K

>80 4.000K



Available RAL colors (Consult)





S150LOM

S150LIM

Light packages



| | | | PCA | 722 | 727 | 730 | 827 | 830 | 840 |
|--------------|---|---|-----------------------|-----------------------|-----------------------|-----------------------|-----------------------|-----------------------|-----------------------|
| W |  |  | ϕ_{LUM} ϕ/W | ϕ_{LUM} ϕ/W | ϕ_{LUM} ϕ/W | ϕ_{LUM} ϕ/W | ϕ_{LUM} ϕ/W | ϕ_{LUM} ϕ/W | ϕ_{LUM} ϕ/W |
| 49,2W | 32 | 500mA | 3,073lm 62lm/W | 4,550lm 92lm/W | 5,368lm 109lm/W | 5,630lm 114lm/W | 4,844lm 98lm/W | 4,844lm 98lm/W | 5,106lm 104lm/W |

Mounting

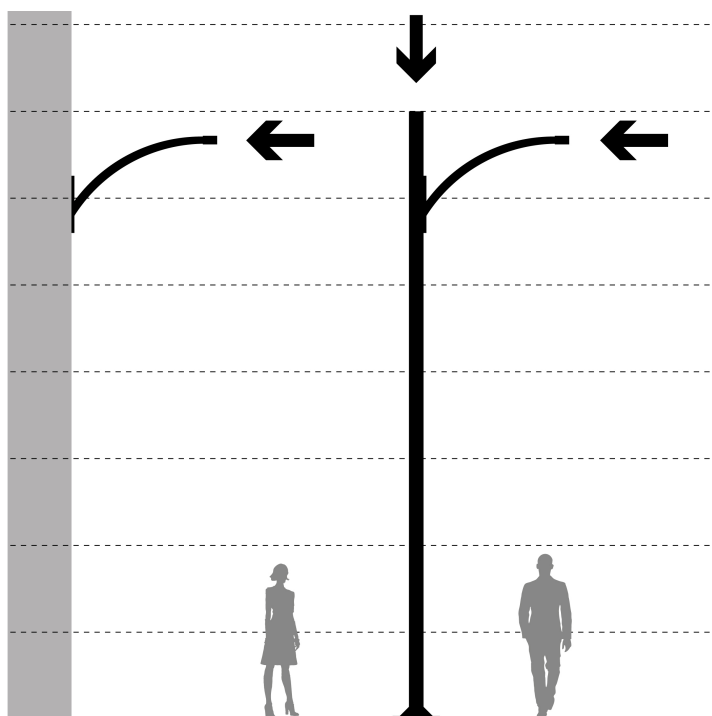

1. Arm Mount



Technologies



Overstorm



OVERSTORM technology is designed for those luminaires that normally face electrically aggressive environments. It provides the product with three spheres of protection: In the outer sphere, an independent surge protector suppresses eventual voltage surges, in the intermediate sphere the drivers are prepared to withstand voltage peaks of up to 6 kV and 10kV. In the nuclear sphere, the protection in the LED module is provided both at its input, for small surges that have not been filtered by the external spheres.

SystemShield



SYSTEMSHIELD technology is designed to guarantee the hours of useful life of luminaires installed in environments where exceeding the maximum operating temperature is possible and even probable. Using thermal probes, the luminaire knows its operating temperature at all times.



CMR



CMR (CORA MANAGER READY) identifies the prilux luminaires compatible with the CORA MANAGER system that provides the luminaires with control, regulation and programming.



Solutions

S



Cora Manager

description



One of the key pieces to achieve the path towards smart cities is lighting. Lighting management systems are advancing by leaps and bounds, prioritizing primary objectives such as service quality, cost reduction and care for the environment. CORA Manager is the control system developed by Prilux that, together with our compatible luminaires that provides intelligent management of public lighting, maintaining harmony between sustainable development and quality of life for citizens, while promoting safety and saving.

Info



For more information on the different solutions compatible with this luminaire, consult the following BIDI codes or on the web www.prilux.es

Info

Includes Optical Group with ENAC tests and ENEC, CB, N certification