

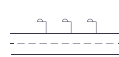

MADE IN SPAIN  
Design by PRILUX



## Applications



Routes



Autoroutes

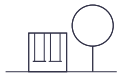

Parcs



Viaducs



Zones résidentielles



Zones piétonnes



Pistes cyclables



Parkings



Périmètres

## Certifications





## Spécifications (Luminaire de la série)

 <b>Tension D` Alimentation (V)</b>	220-240V	 <b>Dimensions</b>	478x670x107mm
<b>Hz Fréquence (Hz)</b>	50-60Hz	 <b>Poids</b>	8Kg
 <b>Intensité (A)</b>	350mA	 <b>Résistance au vent</b>	0,072m2
$\phi$ <b>Facteur de puissance (Cos fi)</b>	0.9	 <b>Température de service</b>	-40~+50°C
 <b>Nombre de led</b>	12	$\phi_{LUM}$ <b>Flux (lm)</b>	1.985lm
 <b>Atténuation</b>	8N - DALI	<b>Performance</b>	0,85%
 <b>Prot. de comm. pour reprogr.</b>	CMR	 <b>Isolation électrique</b>	CI
 <b>Indice d'étanchéité IP</b>	IP66	 <b>Heures de vie</b>	L90 B10 >200.000h
 <b>IK Protection contre des impacts</b>	IK09	$\phi/W$ <b>Efficacité</b>	149lm/W
 <b>Couleur du corps</b>	9007	Prilux garantit une tolérance de $\pm 10\%$ dans les mesures de flux lumineux.	
 <b>Matériau du diffuseur</b>	VT-T		
 <b>Corps</b>	AL iap		
<b>K Température de couleur</b>	4.000K		
 <b>CRI Indice de rendu des couleurs</b>	>70		
 <b>Optique</b>	VA00K0M		

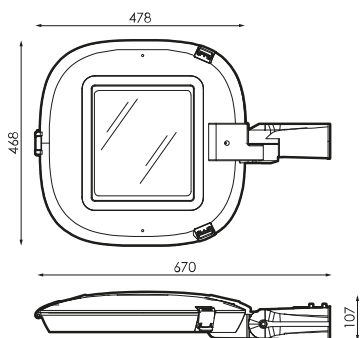
## Dimensions



## Les références

	$W_{LED}$	$W$		$\phi$	$\phi_{LED}$	$\phi_{LUM}$	$\phi/W$		$K$	
<b>572804</b>	12W	13,3W	350mA	2.399lm	2.335lm	1.985lm	149lm/W	0,85%	12	4.000K

## Photométrie

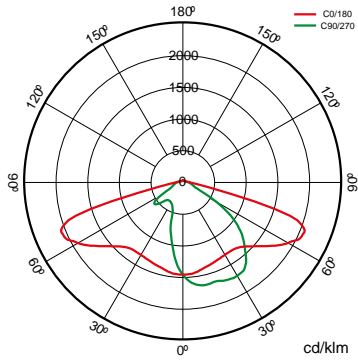

## Sur demande



Dali

Double niveau avec ligne de commande

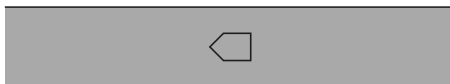

Classe II



PC-T (IK10)

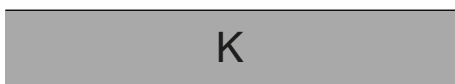

PCAmbre

>70 2.700K

>80 3.000K

>80 4.000K

>70 2.700K



Couleurs RAL disponibles (Consulter)



PPDLOM

SI50LOM

VA00IOP

VA01LOM

VA02LOM

VA03DOP

VA04DOP

VA05IOP

VA06IOP

VA07LOP



VA08LOM

VA00LOM

PEXLOM

## Forfaits légers



			PCA	722	727	730	827	830	840
W			$\phi_{LUM}$ $\phi/W$	$\phi_{LUM}$ $\phi/W$	$\phi_{LUM}$ $\phi/W$	$\phi_{LUM}$ $\phi/W$	$\phi_{LUM}$ $\phi/W$	$\phi_{LUM}$ $\phi/W$	$\phi_{LUM}$ $\phi/W$
<b>13,3W</b>	12	350mA	1.062lm 80lm/W	1.533lm 115lm/W	1.777lm 134lm/W		1.633lm 123lm/W	1.633lm 123lm/W	1.720lm 129lm/W

## Montage



## Accessoires



### 586566

KIT ADAPT. POUR  
MAT DE Ø33MM  
VERSA-ARISA ROAD

### 496636

KIT ADAPT. POUR  
MAT DE Ø42MM  
VERSA-ARISA ROAD

### 496629

KIT ADAPT. POUR  
MAT DE Ø50MM  
VERSA-ARISA ROAD

### 501743

KIT ADAPT. POUR  
MAT DE Ø76MM  
POLIVALENT POUR  
LANTERNES  
ECLAIRAGE ROUTIER  
RAL9007T



## Les technologies



### Overstorm



La technologie OVERSTORM est conçue pour les luminaires qui font normalement face à des environnements électriquement agressifs. Il fournit au produit trois sphères de protection : dans la sphère externe, un parasurtenseur indépendant supprime les surtensions éventuelles, dans la sphère intermédiaire, les pilotes sont préparés pour résister à des pics de tension allant jusqu'à 6 kV et 10 kV. Dans la sphère nucléaire, la protection dans le module LED est assurée aussi bien à son entrée, que pour les petites surtensions qui n'ont pas été filtrées par les sphères extérieures.

### SystemShield



La technologie SYSTEMSHIELD est conçue pour garantir les heures de vie utile des luminaires installés dans des environnements où le dépassement de la température maximale de fonctionnement est possible et même probable. Grâce à des sondes thermiques, le luminaire connaît à tout moment sa température de fonctionnement.



### CMR



CMR (CORA MANAGER READY) identifie les luminaires prilux compatibles avec le système CORA MANAGER qui fournit aux luminaires un contrôle de régulation et de programmation.



## Solutions

S



### Was Outdoor

#### la description

La technologie WAS (White Adaptive System) offre aux luminaires PRILUX la possibilité de modifier à la fois la quantité de lumière qu'ils fournissent et la température de couleur corrélée, CCT. La technologie WAS (White Adaptive System) offre aux luminaires PRILUX la possibilité de modifier à la fois la quantité de lumière qu'ils fournissent et la température de couleur corrélée.



### Safelight

#### la description

SAFELIGHT permet l'éclairage de passages piétons avec des luminaires adaptés avec des optiques spéciales pour cette application qui éclairent avec une lumière blanche avec un niveau continu de 100%.



### Cora Manager

#### la description

L'éclairage est l'un des éléments clés pour tracer la voie vers les villes intelligentes. Les systèmes de gestion de l'éclairage progressent à pas de géant, privilégiant des objectifs prioritaires tels que la qualité de service, la réduction des coûts et le respect de l'environnement. CORA Manager est le système de contrôle développé par Prilux qui, associé à nos luminaires compatibles qui permet une gestion intelligente de l'éclairage public, en maintenant l'harmonie entre le développement durable et la qualité de vie des citoyens, tout en favorisant la sécurité et l'économie.

#### Info

Pour plus d'informations sur les différentes solutions compatibles avec ce luminaire, consultez les codes BIDI suivants ou sur le web [www.prilux.es](http://www.prilux.es)

<b>Info</b>	
Lignes compactes	