



MADE IN SPAIN
Design by PRILUX



Applications



Roads

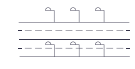

Motorways

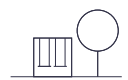

Parks



Viaducts



Residential Areas



Pedestrian Zones



Cycle lanes



Car parks





















Industrial

Certifications



Specifications (Series luminaires)



 Voltage (V)	220-240V	 Measures	478x670x107mm
Hz Frecuency (Hz)	50-60Hz	 Weight	8Kg
 Current (A)	700mA	 Wind Resistance	0,072m2
ϕ Power factor (Cos fi)	0.97	 Operating temperature	-40~+50°C
 LED number	12	ϕ_{LUM} Flux (lm)	3.478lm
 Dimming	8N - DALI	Performance	0,85%
 Comm. Prot. for reprogr.	CMR	 Electrical isolation	CI
 IP Tightness index	IP66	 Lifetime	L90 B10 >200.000h
 IK Impact resistance	IK09	ϕ/W Efficacy	131lm/W
 Body color	9007		
 Diffuser Material	VT-T		
 Body	AL iap		
K Colour temperature	3.000K		
 CRI Colour rendering index	>70		
 Optical	VA00K0M		

Prilux guarantees a $\pm 10\%$ tolerance in light flux measurements.

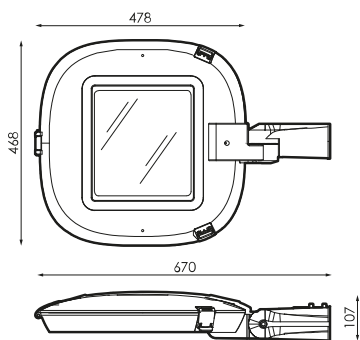
Dimensions



References

	W_{LED}	W		ϕ	ϕ_{LED}	ϕ_{LUM}	ϕ/W		K	
572880	24W	26,5W	700mA	4.239lm	4.092lm	3.478lm	131lm/W	0,85%	12	3.000K

Photometry

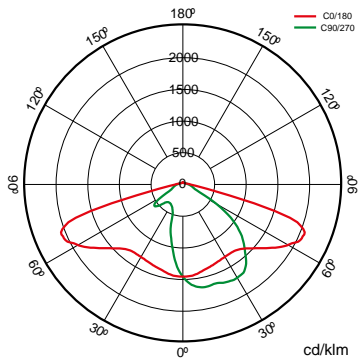

On request



Dali

Double Level with Line of Command

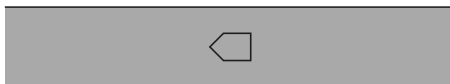

Class II



PC-T (IK10)

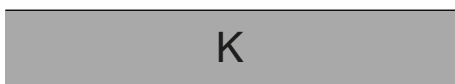

PCAmbar

>70 2.700K

>80 3.000K

>80 4.000K

>70 2.700K



Available RAL colors (Consult)



PPDL0M

SI50L0M

VA00I0P

VA01L0M

VA02L0M

VA03D0P

VA04D0P

VA05I0P

VA06I0P

VA07L0P



VA08L0M

VA00L0M

PEXL0M

Light packages



			PCA	722	727	730	827	830	840
W			ϕ_{LUM} ϕ/W	ϕ_{LUM} ϕ/W	ϕ_{LUM} ϕ/W	ϕ_{LUM} ϕ/W	ϕ_{LUM} ϕ/W	ϕ_{LUM} ϕ/W	ϕ_{LUM} ϕ/W
26,5W	12	700mA	1.851lm 70lm/W	2.823lm 107lm/W	3.272lm 123lm/W		3.006lm 113lm/W	3.006lm 113lm/W	3.168lm 120lm/W

Mounting

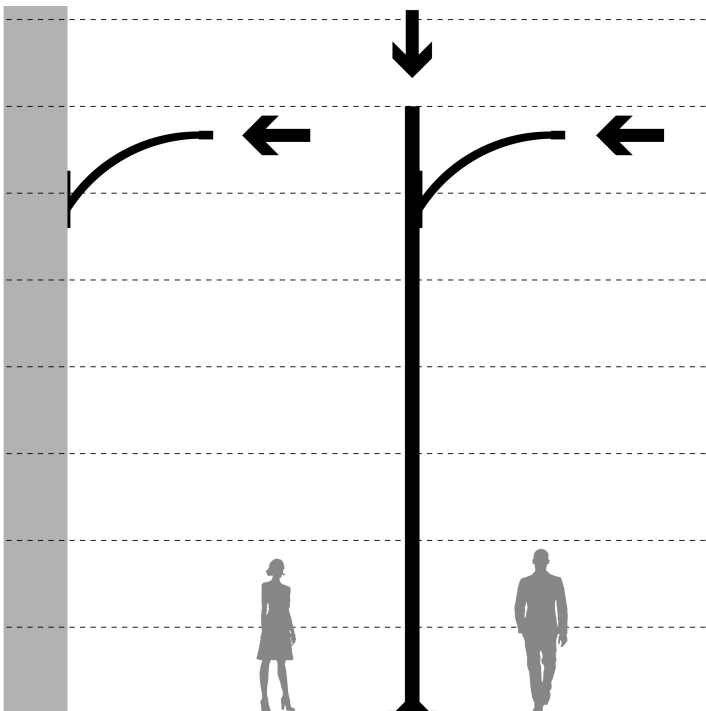

Accessories



586566

KIT ADAP. A POSTE
Ø33MM VERSA-
ARISA ROAD

496636

KIT ADAP. A POSTE
Ø42MM VERSA-
ARISA ROAD

496629

KIT ADAP. A POSTE
Ø50MM VERSA-
ARISA ROAD

501743

KIT ADAP. A POSTE
Ø76MM
POLIVALENTE TECN.
RAL9007T

Technologies



Overstorm



OVERSTORM technology is designed for those luminaires that normally face electrically aggressive environments. It provides the product with three spheres of protection: In the outer sphere, an independent surge protector suppresses eventual voltage surges, in the intermediate sphere the drivers are prepared to withstand voltage peaks of up to 6 kV and 10kV. In the nuclear sphere, the protection in the LED module is provided both at its input, for small surges that have not been filtered by the external spheres.

SystemShield



SYSTEMSHIELD technology is designed to guarantee the hours of useful life of luminaires installed in environments where exceeding the maximum operating temperature is possible and even probable. Using thermal probes, the luminaire knows its operating temperature at all times.



CMR



CMR (CORA MANAGER READY) identifies the prilux luminaires compatible with the CORA MANAGER system that provides the luminaires with control, regulation and programming.

Solutions

S



Was Outdoor

description



WAS (White Adaptive System) technology provides PRILUX luminaires with the ability to change both the amount of light they provide and the correlated color temperature, CCT. WAS (White Adaptive System) technology provides PRILUX luminaires with the ability to change both the amount of light they provide and the correlated color temperature



Safelight

description



SAFELIGHT allows the lighting of zebra crossings with road luminaires adapted with special optics for this application that illuminate with white light with a continuous level of 100%



Cora Manager

description



One of the key pieces to achieve the path towards smart cities is lighting. Lighting management systems are advancing by leaps and bounds, prioritizing primary objectives such as service quality, cost reduction and care for the environment. CORA Manager is the control system developed by Prilux that, together with our compatible luminaires that provides intelligent management of public lighting, maintaining harmony between sustainable development and quality of life for citizens, while promoting safety and saving.

Info



For more information on the different solutions compatible with this luminaire, consult the following BIDI codes or on the web www.prilux.es

Info	
Compact design	