

**MADE IN SPAIN**  
Design by PRILUX



## Applications



Roads

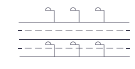

Motorways

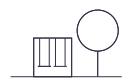

Parks



Viaducts



Residential Areas



Pedestrian Zones



Cycle lanes



Car parks



















Industrial

## Certifications



## Specifications (Series luminaires)



 <b>Voltage (V)</b>	220-240V	 <b>Measures</b>	478x670x107mm
<b>Hz Frecuency (Hz)</b>	50-60Hz	 <b>Weight</b>	8Kg
 <b>Current (A)</b>	1.000mA	 <b>Wind Resistance</b>	0,072m2
$\phi$ <b>Power factor (Cos fi)</b>	0.98	 <b>Operating temperature</b>	-40~+50°C
 <b>LED number</b>	12	$\phi_{LUM}$ <b>Flux (lm)</b>	4.928lm
 <b>Dimming</b>	8N - DALI	<b>Performance</b>	0,85%
 <b>Comm. Prot. for reprogr.</b>	CMR	 <b>Electrical isolation</b>	CI
 <b>IP Tightness index</b>	IP66	 <b>Lifetime</b>	L90 B10 >200.000h
 <b>IK Impact resistance</b>	IK09	$\phi/W$ <b>Efficacy</b>	127lm/W
 <b>Body color</b>	9007		
 <b>Diffuser Material</b>	VT-T		
 <b>Body</b>	AL iap		
<b>K Colour temperature</b>	4.000K		
 <b>CRI Colour rendering index</b>	>70		
 <b>Optical</b>	VA00K0M		

Prilux guarantees a  $\pm 10\%$  tolerance in light flux measurements.

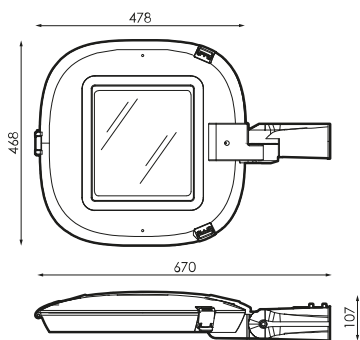
## Dimensions



## References

	$W_{LED}$	$W$		$\phi$	$\phi_{LED}$	$\phi_{LUM}$	$\phi/W$		$K$	
<b>572910</b>	36W	38,8W	1000mA	5.965lm	5.798lm	4.928lm	127lm/W	0,85%	12	4.000K

## Photometry

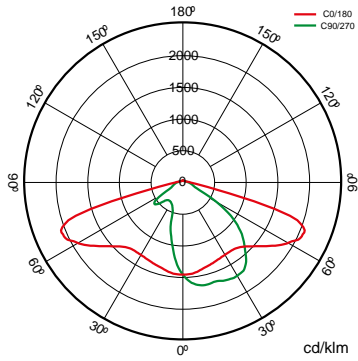

## On request







Dali

---

Double Level with Line of Command



Class II



PC-T (IK10)

**K**

PCAmbar

---

>70 2.700K

---

>80 3.000K

---

>80 4.000K

---

>70 2.700K



Available RAL colors (Consult)



PPDL0M

---

SI50L0M

---

VA00I0P

---

VA01L0M

---

VA02L0M

---

VA03D0P

---

VA04D0P

---

VA05I0P

---

VA06I0P

---

VA07L0P

---

VA08L0M

---



VA00L0M

---

PEXL0M

## Light packages



			PCA	722	727	730	827	830	840
W			$\phi_{LUM}$ $\phi/W$	$\phi_{LUM}$ $\phi/W$	$\phi_{LUM}$ $\phi/W$	$\phi_{LUM}$ $\phi/W$	$\phi_{LUM}$ $\phi/W$	$\phi_{LUM}$ $\phi/W$	$\phi_{LUM}$ $\phi/W$
<b>38,8W</b>	12	1.000mA	2.327lm 63lm/W	3.805lm 98lm/W	4.410lm 114lm/W		4.052lm 104lm/W	4.052lm 104lm/W	4.271lm 110lm/W

## Mounting

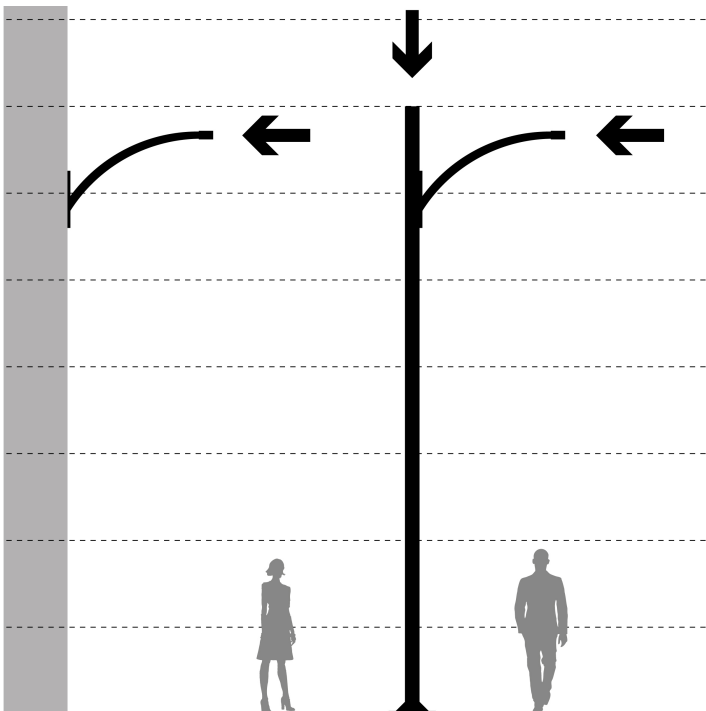

## Accessories



### 586566

KIT ADAP. A POSTE  
Ø33MM VERSA-  
ARISA ROAD

### 496636

KIT ADAP. A POSTE  
Ø42MM VERSA-  
ARISA ROAD

### 496629

KIT ADAP. A POSTE  
Ø50MM VERSA-  
ARISA ROAD

### 501743

KIT ADAP. A POSTE  
Ø76MM  
POLIVALENTE TECN.  
RAL9007T

## Technologies



### Overstorm



OVERSTORM technology is designed for those luminaires that normally face electrically aggressive environments. It provides the product with three spheres of protection: In the outer sphere, an independent surge protector suppresses eventual voltage surges, in the intermediate sphere the drivers are prepared to withstand voltage peaks of up to 6 kV and 10kV. In the nuclear sphere, the protection in the LED module is provided both at its input, for small surges that have not been filtered by the external spheres.

### SystemShield



SYSTEMSHIELD technology is designed to guarantee the hours of useful life of luminaires installed in environments where exceeding the maximum operating temperature is possible and even probable. Using thermal probes, the luminaire knows its operating temperature at all times.



### CMR



CMR (CORA MANAGER READY) identifies the prilux luminaires compatible with the CORA MANAGER system that provides the luminaires with control, regulation and programming.

## Solutions

S



### Was Outdoor

#### description



WAS (White Adaptive System) technology provides PRILUX luminaires with the ability to change both the amount of light they provide and the correlated color temperature, CCT. WAS (White Adaptive System) technology provides PRILUX luminaires with the ability to change both the amount of light they provide and the correlated color temperature



### Safelight

#### description



SAFELIGHT allows the lighting of zebra crossings with road luminaires adapted with special optics for this application that illuminate with white light with a continuous level of 100%



### Cora Manager

#### description



One of the key pieces to achieve the path towards smart cities is lighting. Lighting management systems are advancing by leaps and bounds, prioritizing primary objectives such as service quality, cost reduction and care for the environment. CORA Manager is the control system developed by Prilux that, together with our compatible luminaires that provides intelligent management of public lighting, maintaining harmony between sustainable development and quality of life for citizens, while promoting safety and saving.

#### Info



For more information on the different solutions compatible with this luminaire, consult the following BIDI codes or on the web [www.prilux.es](http://www.prilux.es)

<b>Info</b>	
Compact design	