

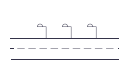

MADE IN SPAIN
Design by PRILUX



Aplicaciones



Carreteras



Autovías

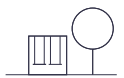

Parques



Viaductos



Zonas Residenciales



Zonas Peatonales



Carril bici



Parkings















Perímetros

Certificaciones



Especificaciones (Luminarias de Serie)

	Tensión (V)	220-240V
Hz	Frecuencia (Hz)	50-60Hz
	Intensidad (A)	350mA
ϕ	Factor de potencia (Cos fi)	0.91
	Número de leds	32
	Regulación	8N - DALI
	Prot. de com. para reprogr.	CMR
	IP Índice de estanqueidad	IP66
	IK Protección contra impactos	IK09
	Color cuerpo	9007
	Difusor	VT-T
	Cuerpo	AL iap
K	Temperatura de color	3.000K
	CRI Índice de repr. cromática	>70
	Óptica	VA00K0M



	Dimensiones	478x670x107mm
	Peso	8Kg
	Resistencia al Viento	0,072m2
	Temp. de funcionamiento	-40~+50°C
ϕ_{LUM}	Flujo luminoso (lm)	4.876lm
	Rendimiento	0,85%
	Aislamiento eléctrico	CI
	Vida útil	L90 B10 >200.000h
ϕ/W	Eficacia	142lm/W

Prilux garantiza una tolerancia $\pm 10\%$ en las medidas de flujo lumínico.

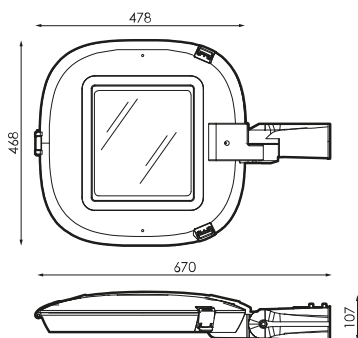
Dimensiones



Referencias

	W_{LED}	W		ϕ	ϕ_{LED}	ϕ_{LUM}	ϕ/W		K	
573009	32W	34,3W	350mA	6.113lm	5.736lm	4.876lm	142lm/W	0,85%	32	3.000K

Fotometría

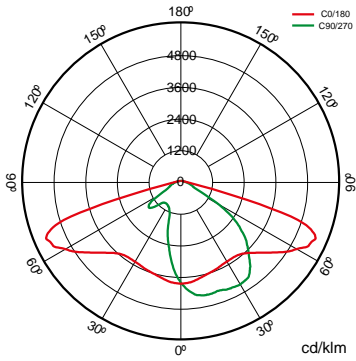

Bajo Pedido



Clase II



Doble Nivel con Línea de Mando



PC-T (IK10)



PC Ambar

>70 2.700K

>80 3.000K

>80 4.000K

>70 2.200K



Disponibles colores RAL (Consultar)



PPDL0M

SI50L0M

VA00I0P

VA01L0M

VA02L0M

VA03D0P

VA04D0P

VA05I0P



VA06I0P

VA07L0P

VA08L0M

Paquetes lumínicos



			PCA	722	727	730	827	830	840
W			ϕ_{LUM} ϕ/W	ϕ_{LUM} ϕ/W	ϕ_{LUM} ϕ/W	ϕ_{LUM} ϕ/W	ϕ_{LUM} ϕ/W	ϕ_{LUM} ϕ/W	ϕ_{LUM} ϕ/W
34,3W	32	350mA	2.744lm 80lm/W	3.958lm 115lm/W	4.587lm 134lm/W		4.215lm 123lm/W	4.215lm 123lm/W	4.442lm 130lm/W

Montaje

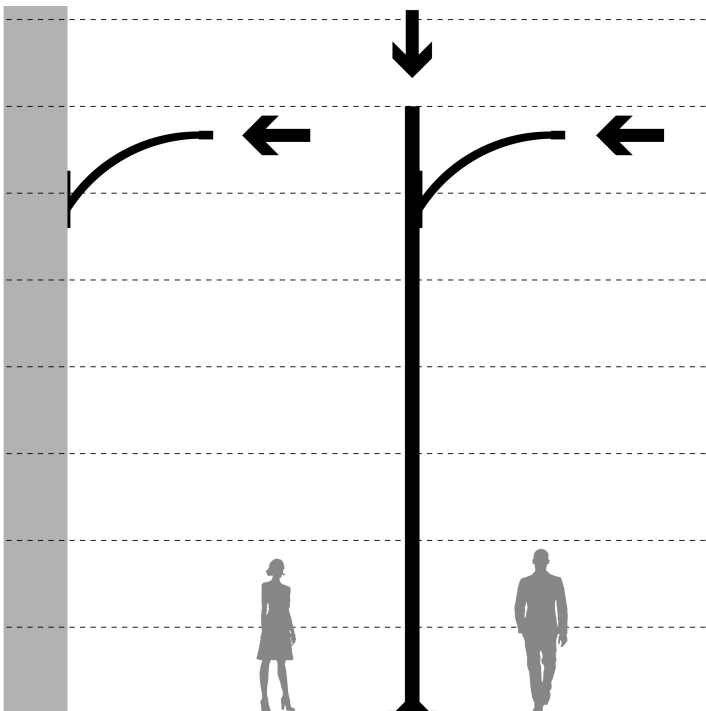

Accesorios



586566

KIT ADAP. A POSTE
Ø33MM VERSA-
ARISA ROAD

496636

KIT ADAP. A POSTE
Ø42MM VERSA-
ARISA ROAD

496629

KIT ADAP. A POSTE
Ø50MM VERSA-
ARISA ROAD

501743

KIT ADAP. A POSTE
Ø76MM
POLIVALENTE TECN.
RAL9007T



Tecnologías



Overstorm



La tecnología OVERSTORM está pensada para aquellas luminarias que normalmente se enfrentan a entornos eléctricamente agresivos. Dota al producto de tres esferas de protección: En la esfera exterior un protector contra sobretensiones independiente suprime las eventuales subidas de tensión, la esfera intermedia los drivers están preparados para soportar picos de tensión de hasta 6 kV y 10kV. En la esfera nuclear la protección en el módulo LED se proporciona tanto en su entrada, para las pequeñas sobretensiones que no han sido filtradas por las esferas externas.

SystemShield



La tecnología SYSTEMSHIELD está pensada para garantizar las horas de vida útil de luminarias instaladas en entornos en los que superar la temperatura máxima de operación es posible e incluso probable. Mediante sondas térmicas la luminaria conoce en todo momento su temperatura de funcionamiento.



CMR



CMR (CORA MANAGER READY) identifica a las luminarias de prilux compatibles con el sistema CORA MANAGER que dota a las luminarias de control regulación y programación.

Soluciones

S



Was Outdoor

descripción



La tecnología WAS (White Adaptative System) proporciona a las luminarias PRILUX la capacidad de cambiar tanto la cantidad de luz que proporcionan como la temperatura de color correlacionada, CCT. La tecnología WAS (White Adaptative System) proporciona a las luminarias PRILUX la capacidad de cambiar tanto la cantidad de luz que proporcionan como la temperatura de color correlacionada



Safelight

descripción



SAFELIGHT permite la iluminación de pasos de cebra con luminarias viales adaptadas con ópticas especiales para esta aplicación que iluminan con luz blanca con un nivel continuo del 100%.



Cora Manager

descripción



La iluminación es clave para ciudades inteligentes. Los sistemas de gestión de alumbrado avanzan rápidamente con enfoque en calidad, reducción de costes y cuidado ambiental. CORA Manager de Prilux, junto con nuestras luminarias, ofrece gestión inteligente de alumbrado público para desarrollo sostenible, calidad de vida, seguridad y ahorro.

Info



Para obtener más información de las diferentes soluciones compatibles con esta luminaria consulte en los siguientes códigos BIDI o en la web www.prilux.es

Info	
Diseño compacto	