

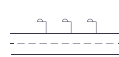

MADE IN SPAIN
Design by PRILUX



Applications



Routes



Autoroutes

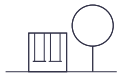

Parcs



Viaducs



Zones résidentielles



Zones piétonnes



Pistes cyclables



Parkings



Périmètres

Certifications



Spécifications (Luminaire de la série)



| | | | |
|--|-----------|---|-------------------|
|  Tension D` Alimentation (V) | 220-240V |  Dimensions | 478x670x107mm |
| Hz Fréquence (Hz) | 50-60Hz |  Poids | 8Kg |
|  Intensité (A) | 350mA |  Résistance au vent | 0,072m2 |
| ϕ Facteur de puissance (Cos fi) | 0.91 |  Température de service | -40~+50°C |
|  Nombre de led | 32 | ϕ_{LUM} Flux (lm) | 5.126lm |
|  Atténuation | 8N - DALI | Performance | 0,85% |
|  Prot. de comm. pour reprogr. | CMR |  Isolation électrique | CI |
|  Indice d'étanchéité IP | IP66 |  Heures de vie | L90 B10 >200.000h |
|  IK Protection contre des impacts | IK09 | ϕ/W Efficacité | 149lm/W |
|  Couleur du corps | 9007 | | |
|  Matériau du diffuseur | VT-T | | |
|  Corps | AL iap | | |
| K Température de couleur | 4.000K | | |
|  CRI Indice de rendu des couleurs | >70 | | |
|  Optique | VA00K0M | | |

Prilux garantit une tolérance de $\pm 10\%$ dans les mesures de flux lumineux.

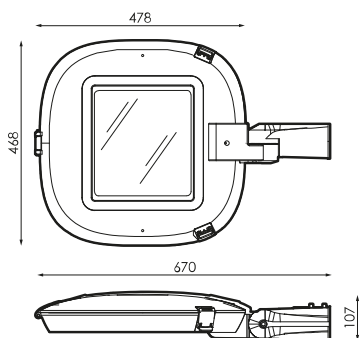
Dimensions



Les références

|  | W_{LED} | W |  | ϕ | ϕ_{LED} | ϕ_{LUM} | ϕ/W |  | K | |
|---|-----------|-------|---|---------|--------------|--------------|----------|---|----|--------|
| 573016 | 32W | 34,3W | 350mA | 6.397lm | 6.031lm | 5.126lm | 149lm/W | 0,85% | 32 | 4.000K |

Photométrie

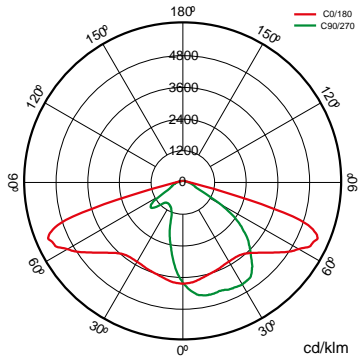

Sur demande



Classe II



Double niveau avec ligne de commande



PC-T (IK10)



PCAmbre

>70 2.700K

>80 3.000K

>80 4.000K

>70 2.700K



Couleurs RAL disponibles (Consulter)



PPDL0M

SI50L0M

VA00I0P

VA01L0M

VA02L0M

VA03D0P

VA04D0P

VA05I0P



VA06I0P

VA07L0P

VA08L0M

Forfaits légers



| | | | PCA | 722 | 727 | 730 | 827 | 830 | 840 |
|--------------|---|---|-----------------------|-----------------------|-----------------------|-----------------------|-----------------------|-----------------------|-----------------------|
| W |  |  | ϕ_{LUM} ϕ/W | ϕ_{LUM} ϕ/W | ϕ_{LUM} ϕ/W | ϕ_{LUM} ϕ/W | ϕ_{LUM} ϕ/W | ϕ_{LUM} ϕ/W | ϕ_{LUM} ϕ/W |
| 34,3W | 32 | 350mA | 2.744lm 80lm/W | 3.958lm 115lm/W | 4.587lm 134lm/W | | 4.215lm 123lm/W | 4.215lm 123lm/W | 4.442lm 130lm/W |

Montage

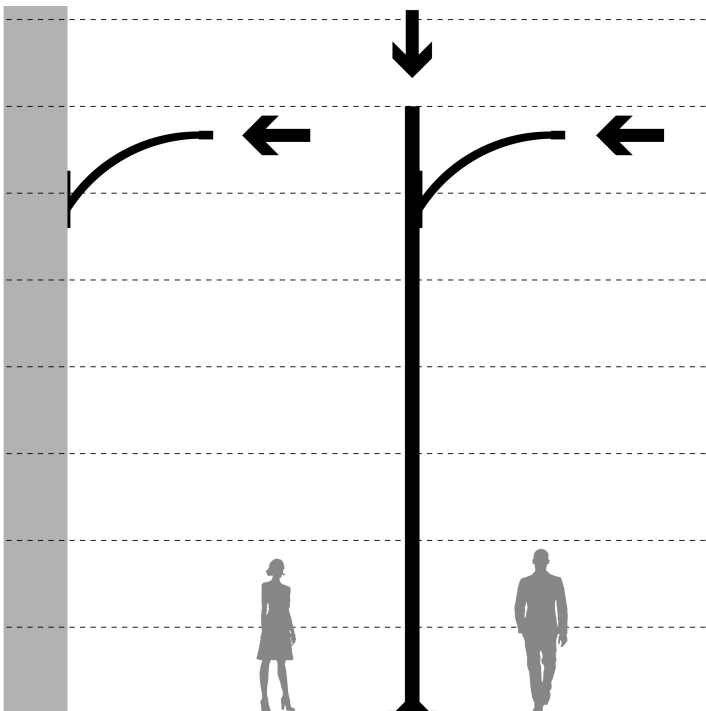

Accessoires



586566

KIT ADAPT. POUR
MAT DE Ø33MM
VERSA-ARISA ROAD

496636

KIT ADAPT. POUR
MAT DE Ø42MM
VERSA-ARISA ROAD

496629

KIT ADAPT. POUR
MAT DE Ø50MM
VERSA-ARISA ROAD

501743

KIT ADAPT. POUR
MAT DE Ø76MM
POLIVALENT POUR
LANTERNES
ECLAIRAGE ROUTIER
RAL9007T



Les technologies



Overstorm



La technologie OVERSTORM est conçue pour les luminaires qui font normalement face à des environnements électriquement agressifs. Il fournit au produit trois sphères de protection : dans la sphère externe, un parasurtenseur indépendant supprime les surtensions éventuelles, dans la sphère intermédiaire, les pilotes sont préparés pour résister à des pics de tension allant jusqu'à 6 kV et 10 kV. Dans la sphère nucléaire, la protection dans le module LED est assurée aussi bien à son entrée, que pour les petites surtensions qui n'ont pas été filtrées par les sphères extérieures.

SystemShield



La technologie SYSTEMSHIELD est conçue pour garantir les heures de vie utile des luminaires installés dans des environnements où le dépassement de la température maximale de fonctionnement est possible et même probable. Grâce à des sondes thermiques, le luminaire connaît à tout moment sa température de fonctionnement.



CMR



CMR (CORA MANAGER READY) identifie les luminaires prilux compatibles avec le système CORA MANAGER qui fournit aux luminaires un contrôle de régulation et de programmation.

Solutions

S



Was Outdoor

la description

La technologie WAS (White Adaptive System) offre aux luminaires PRILUX la possibilité de modifier à la fois la quantité de lumière qu'ils fournissent et la température de couleur corrélée, CCT. La technologie WAS (White Adaptive System) offre aux luminaires PRILUX la possibilité de modifier à la fois la quantité de lumière qu'ils fournissent et la température de couleur corrélée.



Safelight

la description

SAFELIGHT permet l'éclairage de passages piétons avec des luminaires adaptés avec des optiques spéciales pour cette application qui éclairent avec une lumière blanche avec un niveau continu de 100%.



Cora Manager

la description

L'éclairage est l'un des éléments clés pour tracer la voie vers les villes intelligentes. Les systèmes de gestion de l'éclairage progressent à pas de géant, privilégiant des objectifs prioritaires tels que la qualité de service, la réduction des coûts et le respect de l'environnement. CORA Manager est le système de contrôle développé par Prilux qui, associé à nos luminaires compatibles qui permet une gestion intelligente de l'éclairage public, en maintenant l'harmonie entre le développement durable et la qualité de vie des citoyens, tout en favorisant la sécurité et l'économie.

Info

Pour plus d'informations sur les différentes solutions compatibles avec ce luminaire, consultez les codes BIDI suivants ou sur le web www.prilux.es

| | |
|------------------|---|
| Info |  |
| Lignes compactes | |