

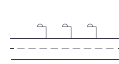

MADE IN SPAIN  
Design by PRILUX



## Aplicaciones



Carreteras



Autovías

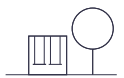

Parques



Viaductos



Zonas Residenciales



Zonas Peatonales



Carril bici



Parkings





















Perímetros

## Certificaciones



## Especificaciones (Luminarias de Serie)



 <b>Tensión (V)</b>	220-240V	 <b>Dimensiones</b>	478x670x107mm
<b>Hz Frecuencia (Hz)</b>	50-60Hz	 <b>Peso</b>	8Kg
 <b>Intensidad (A)</b>	500mA	 <b>Resistencia al Viento</b>	0,072m2
$\phi$ <b>Factor de potencia (Cos fi)</b>	0.97	 <b>Temp. de funcionamiento</b>	-40~+50°C
 <b>Número de leds</b>	32	$\phi_{LUM}$ <b>Flujo luminoso (lm)</b>	8972lm
 <b>Regulación</b>	8N - DALI	<b>Rendimiento</b>	0,85%
 <b>Prot. de com. para reprogr.</b>	CMR	 <b>Aislamiento eléctrico</b>	CI
 <b>IP Índice de estanqueidad</b>	IP66	 <b>Vida útil</b>	L90 B10 >200.000h
 <b>IK Protección contra impactos</b>	IK09	$\phi/W$ <b>Eficacia</b>	131lm/W
 <b>Color cuerpo</b>	9007		
 <b>Difusor</b>	VT-T		
 <b>Cuerpo</b>	AL iap		
<b>K Temperatura de color</b>	3.000K		
 <b>CRI Índice de repr. cromática</b>	>70		
 <b>Óptica</b>	VA00K0M		

Prilux garantiza una tolerancia  $\pm 10\%$  en las medidas de flujo lumínico.

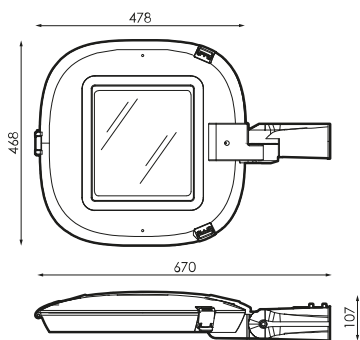
## Dimensiones



## Referencias

	$W_{LED}$	W		$\phi$	$\phi_{LED}$	$\phi_{LUM}$	$\phi/W$		K	
<b>573047</b>	64W	68,7W	500mA	11305lm	10555lm	8972lm	131lm/W	0,85%	32	3.000K

## Fotometría

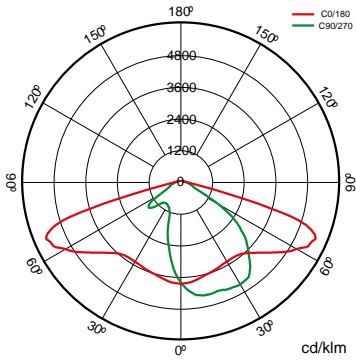

## Bajo Pedido



Clase II



Doble Nivel con Línea de Mando



PC-T (IK10)



PC Ambar

>70 2.700K

>80 3.000K

>80 4.000K

>70 2.200K



Disponibles colores RAL (Consultar)



PPDL0M

SI50L0M

VA00I0P

VA01L0M

VA02L0M

VA03D0P

VA04D0P

VA05I0P



VA06I0P

VA07L0P

VA08L0M

## Paquetes lumínicos



			PCA	722	727	730	827	830	840
W			$\phi_{LUM}$ $\phi/W$	$\phi_{LUM}$ $\phi/W$	$\phi_{LUM}$ $\phi/W$	$\phi_{LUM}$ $\phi/W$	$\phi_{LUM}$ $\phi/W$	$\phi_{LUM}$ $\phi/W$	$\phi_{LUM}$ $\phi/W$
<b>68,7W</b>	32	500mA	4.777lm 70lm/W	7.283lm 106lm/W	8.441lm 123lm/W		7.755lm 113lm/W	7.755lm 113lm/W	8.175lm 119lm/W

## Montaje

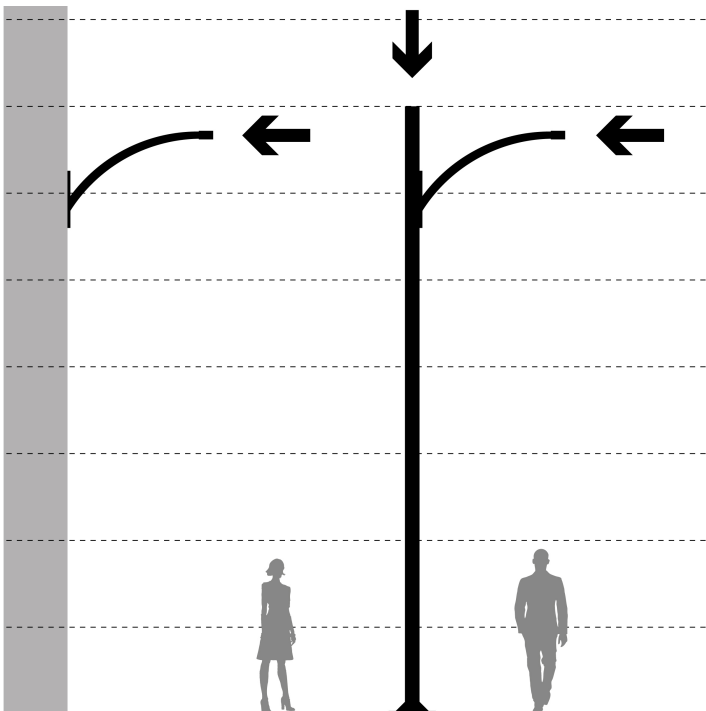

## Accesorios



### 586566

KIT ADAP. A POSTE  
Ø33MM VERSA-  
ARISA ROAD

### 496636

KIT ADAP. A POSTE  
Ø42MM VERSA-  
ARISA ROAD

### 496629

KIT ADAP. A POSTE  
Ø50MM VERSA-  
ARISA ROAD

### 501743

KIT ADAP. A POSTE  
Ø76MM  
POLIVALENTE TECN.  
RAL9007T



## Tecnologías



### Overstorm



La tecnología OVERSTORM está pensada para aquellas luminarias que normalmente se enfrentan a entornos eléctricamente agresivos. Dota al producto de tres esferas de protección: En la esfera exterior un protector contra sobretensiones independiente suprime las eventuales subidas de tensión, la esfera intermedia los drivers están preparados para soportar picos de tensión de hasta 6 kV y 10kV. En la esfera nuclear la protección en el módulo LED se proporciona tanto en su entrada, para las pequeñas sobretensiones que no han sido filtradas por las esferas externas.

### SystemShield



La tecnología SYSTEMSHIELD está pensada para garantizar las horas de vida útil de luminarias instaladas en entornos en los que superar la temperatura máxima de operación es posible e incluso probable. Mediante sondas térmicas la luminaria conoce en todo momento su temperatura de funcionamiento.



### CMR



CMR (CORA MANAGER READY) identifica a las luminarias de prilux compatibles con el sistema CORA MANAGER que dota a las luminarias de control regulación y programación.

## Soluciones

S



### Was Outdoor

#### descripción



La tecnología WAS (White Adaptative System) proporciona a las luminarias PRILUX la capacidad de cambiar tanto la cantidad de luz que proporcionan como la temperatura de color correlacionada, CCT. La tecnología WAS (White Adaptative System) proporciona a las luminarias PRILUX la capacidad de cambiar tanto la cantidad de luz que proporcionan como la temperatura de color correlacionada



### Cora Manager

#### descripción



La iluminación es clave para ciudades inteligentes. Los sistemas de gestión de alumbrado avanzan rápidamente con enfoque en calidad, reducción de costes y cuidado ambiental. CORA Manager de Prilux, junto con nuestras luminarias, ofrece gestión inteligente de alumbrado público para desarrollo sostenible, calidad de vida, seguridad y ahorro.



### Safelight

#### descripción



SAFELIGHT permite la iluminación de pasos de cebra con luminarias viales adaptadas con ópticas especiales para esta aplicación que iluminan con luz blanca con un nivel continuo del 100%.

#### Info



Para obtener más información de las diferentes soluciones compatibles con esta luminaria consulte en los siguientes códigos BIDI o en la web [www.prilux.es](http://www.prilux.es)

<b>Info</b>	
Diseño compacto	