

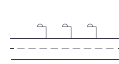

MADE IN SPAIN
Design by PRILUX



Aplicaciones



Carreteras



Autovías

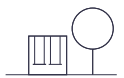

Parques



Viaductos



Zonas Residenciales



Zonas Peatonales



Carril bici



Parkings





















Perímetros

Certificaciones





Especificaciones (Luminarias de Serie)

 Tensión (V)	220-240V	 Dimensiones	478x670x107mm
Hz Frecuencia (Hz)	50-60Hz	 Peso	8Kg
 Intensidad (A)	700mA	 Resistencia al Viento	0,072m2
ϕ Factor de potencia (Cos fi)	0.97	 Temp. de funcionamiento	-40~+50°C
 Número de leds	32	ϕ_{LUM} Flujo luminoso (lm)	9432lm
 Regulación	8N - DALI	Rendimiento	0,85%
 Prot. de com. para reprogr.	CMR	 Aislamiento eléctrico	CI
 IP Índice de estanqueidad	IP66	 Vida útil	L90 B10 >200.000h
 IK Protección contra impactos	IK09	ϕ/W Eficacia	137lm/W
 Color cuerpo	9007	Prilux garantiza una tolerancia $\pm 10\%$ en las medidas de flujo lumínico.	
 Difusor	VT-T		
 Cuerpo	AL iap		
K Temperatura de color	4.000K		
 CRI Índice de repr. cromática	>70		
 Óptica	VA00K0M		

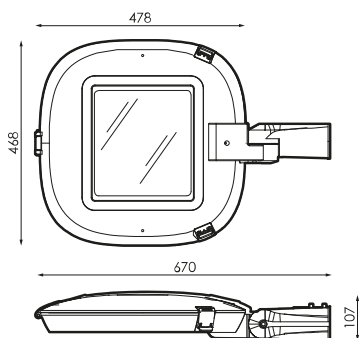
Dimensiones



Referencias

	W_{LED}	W		ϕ	ϕ_{LED}	ϕ_{LUM}	ϕ/W		K	
573054	64W	68,7W	700mA	11831lm	11096lm	9432lm	137lm/W	0,85%	32	4.000K

Fotometría

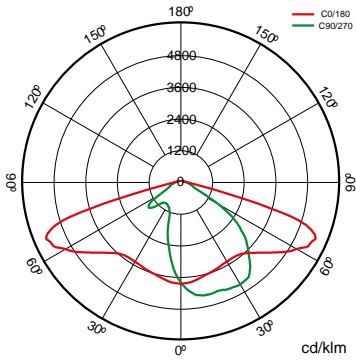

Bajo Pedido



Clase II



Doble Nivel con Línea de Mando



PC-T (IK10)



PC Ambar

>70 2.700K

>80 3.000K

>80 4.000K

>70 2.200K



Disponibles colores RAL (Consultar)



PPDL0M

SI50L0M

VA00I0P

VA01L0M

VA02L0M

VA03D0P

VA04D0P

VA05I0P



VA06I0P

VA07L0P

VA08L0M

Paquetes lumínicos



			PCA	722	727	730	827	830	840
W			ϕ_{LUM} ϕ/W	ϕ_{LUM} ϕ/W	ϕ_{LUM} ϕ/W	ϕ_{LUM} ϕ/W	ϕ_{LUM} ϕ/W	ϕ_{LUM} ϕ/W	ϕ_{LUM} ϕ/W
68,7W	32	700mA	4.777lm 70lm/W	7.283lm 106lm/W	8.441lm 123lm/W		7.755lm 113lm/W	7.755lm 113lm/W	8.175lm 119lm/W

Montaje

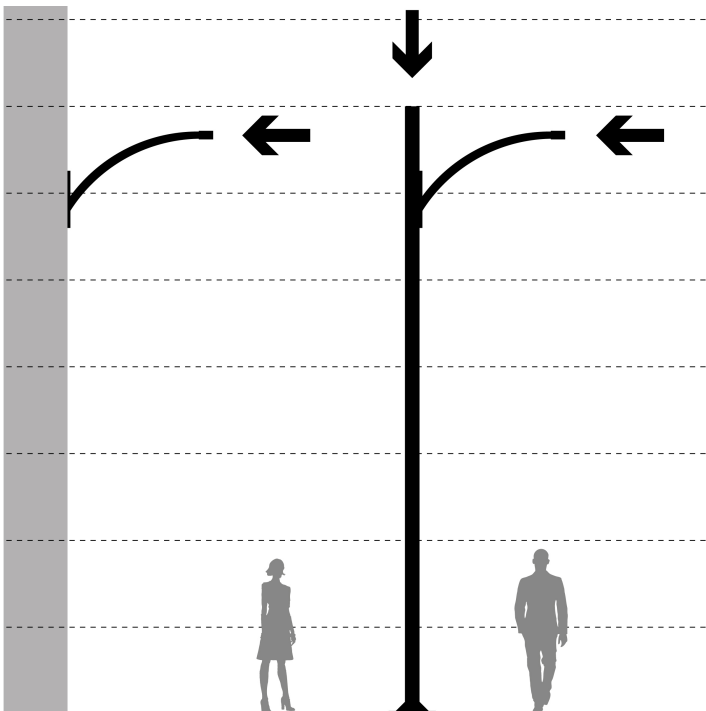

Accesorios



586566

KIT ADAP. A POSTE
Ø33MM VERSA-
ARISA ROAD

496636

KIT ADAP. A POSTE
Ø42MM VERSA-
ARISA ROAD

496629

KIT ADAP. A POSTE
Ø50MM VERSA-
ARISA ROAD

501743

KIT ADAP. A POSTE
Ø76MM
POLIVALENTE TECN.
RAL9007T



Tecnologías



Overstorm



La tecnología OVERSTORM está pensada para aquellas luminarias que normalmente se enfrentan a entornos eléctricamente agresivos. Dota al producto de tres esferas de protección: En la esfera exterior un protector contra sobretensiones independiente suprime las eventuales subidas de tensión, la esfera intermedia los drivers están preparados para soportar picos de tensión de hasta 6 kV y 10kV. En la esfera nuclear la protección en el módulo LED se proporciona tanto en su entrada, para las pequeñas sobretensiones que no han sido filtradas por las esferas externas.

SystemShield



La tecnología SYSTEMSHIELD está pensada para garantizar las horas de vida útil de luminarias instaladas en entornos en los que superar la temperatura máxima de operación es posible e incluso probable. Mediante sondas térmicas la luminaria conoce en todo momento su temperatura de funcionamiento.



CMR



CMR (CORA MANAGER READY) identifica a las luminarias de prilux compatibles con el sistema CORA MANAGER que dota a las luminarias de control regulación y programación.

Soluciones

S



Was Outdoor

descripción



La tecnología WAS (White Adaptative System) proporciona a las luminarias PRILUX la capacidad de cambiar tanto la cantidad de luz que proporcionan como la temperatura de color correlacionada, CCT. La tecnología WAS (White Adaptative System) proporciona a las luminarias PRILUX la capacidad de cambiar tanto la cantidad de luz que proporcionan como la temperatura de color correlacionada



Cora Manager

descripción



La iluminación es clave para ciudades inteligentes. Los sistemas de gestión de alumbrado avanzan rápidamente con enfoque en calidad, reducción de costes y cuidado ambiental. CORA Manager de Prilux, junto con nuestras luminarias, ofrece gestión inteligente de alumbrado público para desarrollo sostenible, calidad de vida, seguridad y ahorro.



Safelight

descripción



SAFELIGHT permite la iluminación de pasos de cebra con luminarias viales adaptadas con ópticas especiales para esta aplicación que iluminan con luz blanca con un nivel continuo del 100%.

Info



Para obtener más información de las diferentes soluciones compatibles con esta luminaria consulte en los siguientes códigos BIDI o en la web www.prilux.es

Info	
Diseño compacto	