



**MADE IN SPAIN**  
Design by PRILUX



## Certificaciones



## Aplicaciones



Autovías



Carreteras



Carril bici



Parques



Viaductos



Zonas Peatonales



Zonas Residenciales





















Túneles



Parkings

## Especificaciones (Luminarias de Serie)

	<b>Tensión (V)</b>	220-240V
Hz	<b>Frecuencia (Hz)</b>	50-60Hz
	<b>Intensidad (A)</b>	1.000mA
$\phi$	<b>Factor de potencia (Cos fi)</b>	0.99
	<b>Número de leds</b>	64
	<b>Regulación</b>	8N - DALI
	<b>Prot. de com. para reprogr.</b>	CMR
	<b>IP Índice de estanqueidad</b>	IP66
	<b>IK Protección contra impactos</b>	IK09
	<b>Color cuerpo</b>	9007
	<b>Difusor</b>	VT-T
	<b>Cuerpo</b>	AL iap
K	<b>Temperatura de color</b>	4.000K
	<b>CRI Índice de repr. cromática</b>	>70
	<b>Óptica</b>	VA0010P



	<b>Dimensiones</b>	750x336x114mm
	<b>Resistencia al Viento</b>	0,252m2
	<b>Montaje</b>	Montaje en Báculo
	<b>Temp. de funcionamiento</b>	-40~+35°C
$\phi_{LUM}$	<b>Flujo luminoso (lm)</b>	25.392lm
	<b>Aislamiento eléctrico</b>	CI
	<b>Vida útil</b>	L90 B10 >200.000h
$\phi/W$	<b>Eficacia</b>	130lm/W

Prilux garantiza una tolerancia  $\pm 10\%$  en las medidas de flujo lumínico.

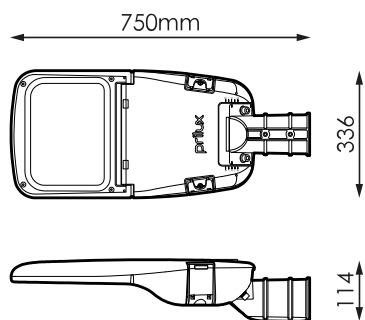
## Dimensiones



## Referencias

	$W_{LED}$	W		$\phi$	$\phi_{LED}$	$\phi_{LUM}$	$\phi/W$		K
574136	192W	194W	1000mA	31.813lm	28.530lm	25.392lm	130lm/W	64	4.000K

## Fotometría

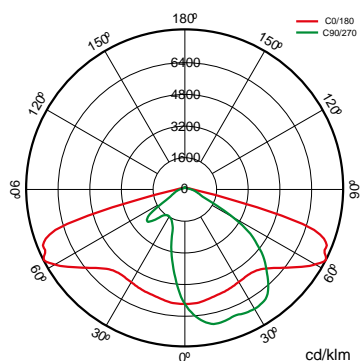

## Bajo Pedido



DALI

Doble Nivel con Línea de Mando



Clase II



PC-T (IK10)

**K**

PC Ambar

>70 2.700K

>80 3.000K

>80 4.000K

>70 2.200K



Disponible colores RAL (Consultar)

+50 °C (Consultar potencias y ópticas disponibles)



PEXL0M

SI50L0M

VA00I0P

VA00L0M

VA02L0M

VA03D0P

VA04D0P

VA05I0P

VA06I0P



VA08L0M

VA01L0M

VA07L0P

## Paquetes lumínicos



			PCA	722	727	730	827	830	840
W			$\phi_{LUM}$ $\phi/W$	$\phi_{LUM}$ $\phi/W$	$\phi_{LUM}$ $\phi/W$	$\phi_{LUM}$ $\phi/W$	$\phi_{LUM}$ $\phi/W$	$\phi_{LUM}$ $\phi/W$	$\phi_{LUM}$ $\phi/W$
<b>194W</b>	64	1.000mA		19.609lm 101lm/W	23.136lm 119lm/W			20.878lm 107lm/W	22.007lm 113lm/W

## Montaje



1. Montaje en Báculo

## Accesorios



**586566**

KIT ADAP. A POSTE  
Ø33MM VERSA-  
ARISA ROAD

**496636**

KIT ADAP. A POSTE  
Ø42MM VERSA-  
ARISA ROAD

**496629**

KIT ADAP. A POSTE  
Ø50MM VERSA-  
ARISA ROAD

**501743**

KIT ADAP. A POSTE  
Ø76MM  
POLIVALENTE TECN.  
RAL9007T



## Tecnologías



### Overstorm



La tecnología OVERSTORM está pensada para aquellas luminarias que normalmente se enfrentan a entornos eléctricamente agresivos. Dota al producto de tres esferas de protección: En la esfera exterior un protector contra sobretensiones independiente suprime las eventuales subidas de tensión, la esfera intermedia los drivers están preparados para soportar picos de tensión de hasta 6 kV y 10kV. En la esfera nuclear la protección en el módulo LED se proporciona tanto en su entrada, para las pequeñas sobretensiones que no han sido filtradas por las esferas externas.

### SystemShield



La tecnología SYSTEMSHIELD está pensada para garantizar las horas de vida útil de luminarias instaladas en entornos en los que superar la temperatura máxima de operación es posible e incluso probable. Mediante sondas térmicas la luminaria conoce en todo momento su temperatura de funcionamiento.



### CMR



CMR (CORA MANAGER READY) identifica a las luminarias de prilux compatibles con el sistema CORA MANAGER que dota a las luminarias de control regulación y programación.



## Cora Manager

### descripción



La iluminación es clave para ciudades inteligentes. Los sistemas de gestión de alumbrado avanzan rápidamente con enfoque en calidad, reducción de costes y cuidado ambiental. CORA Manager de Prilux, junto con nuestras luminarias, ofrece gestión inteligente de alumbrado público para desarrollo sostenible, calidad de vida, seguridad y ahorro.

### Info



Para obtener más información de las diferentes soluciones compatibles con esta luminaria consulte en los siguientes códigos BIDI o en la web [www.prilux.es](http://www.prilux.es)