

MADE IN SPAIN  
Design by PRILUX

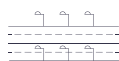

## Applications



Motorways



Roads



Cycle lanes



Parks



Viaducts



Pedestrian Zones



Residential Areas



Tunnels





















Car parks

## Certifications



## Specifications (Series luminaires)

	<b>Voltage (V)</b>	220-240V
Hz	<b>Frecuency (Hz)</b>	50-60Hz
	<b>Current (A)</b>	900mA
$\phi$	<b>Power factor (Cos fi)</b>	0.97
	<b>LED number</b>	80
	<b>Dimming</b>	5N - DALI
	<b>Comm. Prot. for reprogr.</b>	CMR
	<b>IP Tightness index</b>	IP66
	<b>IK Impact resistance</b>	IK09
	<b>Body color</b>	9007
	<b>Diffuser Material</b>	VT-T
	<b>Body</b>	AL iap
<b>K</b>	<b>Colour temperature</b>	4.000K
	<b>CRI Colour rendering index</b>	>70
	<b>Optical</b>	VA0010P



	<b>Measures</b>	750x336x114mm
	<b>Wind Resistance</b>	0,252m2
	<b>Mounting</b>	Crosier Mount
	<b>Operating temperature</b>	-40~+35°C
$\phi_{LUM}$	<b>Flux (lm)</b>	28.827lm
	<b>Electrical isolation</b>	CI
	<b>Lifetime</b>	L90 B10 >200.000h
$\phi/W$	<b>Efficacy</b>	129lm/W

Prilux guarantees a  $\pm 10\%$  tolerance in light flux measurements.

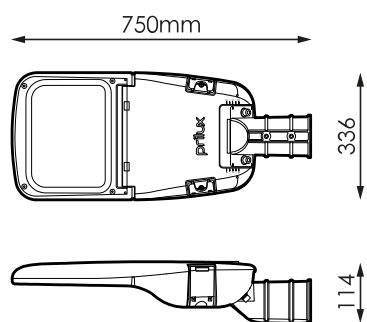
## Dimensions



## References

	$W_{LED}$	$W$		$\phi$	$\phi_{LED}$	$\phi_{LUM}$	$\phi/W$		<b>K</b>
<b>574181</b>	206W	223W	900mA	36.498lm	32.390lm	28.827lm	129lm/W	80	4.000K

## Photometry

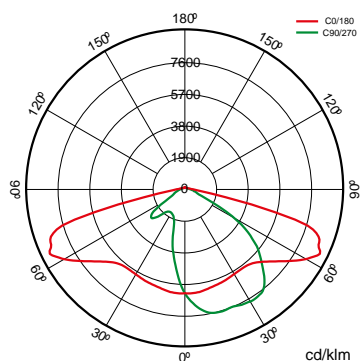

## On request



Dali

Double Level with Line of Command



Class II



PC-T (IK10)

**K**

PCAmbar

>70 2.700K

>80 3.000K

>80 4.000K

>70 2.700K



Available RAL colors (Consult)

50 °C (Consult available powers and optics)



PEXL0M

SI50L0M

VA00I0P

VA00L0M

VA02L0M

VA03D0P

VA04D0P

VA05I0P

VA06I0P



VA08L0M

VA07L0P

VA01L0M

## Light packages



			PCA	722	727	730	827	830	840
W			$\phi_{LUM}$ $\phi/W$	$\phi_{LUM}$ $\phi/W$	$\phi_{LUM}$ $\phi/W$	$\phi_{LUM}$ $\phi/W$	$\phi_{LUM}$ $\phi/W$	$\phi_{LUM}$ $\phi/W$	$\phi_{LUM}$ $\phi/W$
<b>223W</b>	80	900mA		22.260lm 99lm/W	26.264lm 117lm/W			23.702lm 106lm/W	24.983lm 112lm/W

## Mounting

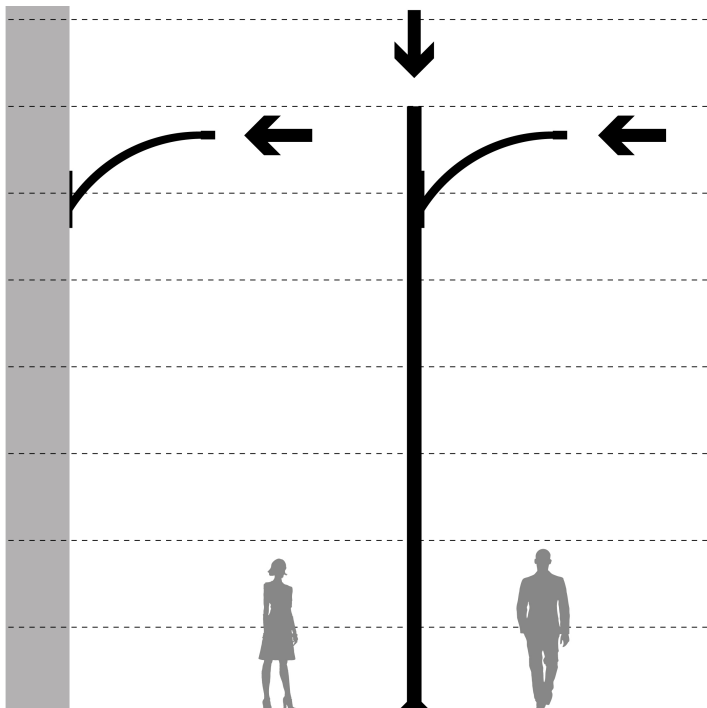

1. Crosier Mount

## Accessories



**586566**

KIT ADAP. A POSTE  
Ø33MM VERSA-  
ARISA ROAD

**496636**

KIT ADAP. A POSTE  
Ø42MM VERSA-  
ARISA ROAD

**496629**

KIT ADAP. A POSTE  
Ø50MM VERSA-  
ARISA ROAD

**501743**

KIT ADAP. A POSTE  
Ø76MM  
POLIVALENTE TECN.  
RAL9007T



---

## Technologies

---



---

### Overstorm



OVERSTORM technology is designed for those luminaires that normally face electrically aggressive environments. It provides the product with three spheres of protection: In the outer sphere, an independent surge protector suppresses eventual voltage surges, in the intermediate sphere the drivers are prepared to withstand voltage peaks of up to 6 kV and 10kV. In the nuclear sphere, the protection in the LED module is provided both at its input, for small surges that have not been filtered by the external spheres.

---

---

### SystemShield



SYSTEMSHIELD technology is designed to guarantee the hours of useful life of luminaires installed in environments where exceeding the maximum operating temperature is possible and even probable. Using thermal probes, the luminaire knows its operating temperature at all times.

---

**Info** i

Luminaire not compatible with CORA MANAGER READY