













Specifications (Series luminaires)

	Voltage (V)	230V
Hz	Frecuency (Hz)	50-60Hz
Φ	Power factor (Cos fi)	>0,5
	Dimming	No
	Bushing type	GU10
	IP Tightness index	IP20
K	Colour temperature	3.000K
	CRI Colour rendering index	>80
	Opening angle	60°
	Measures	50x56mm
	Operating temperature	-5°C~+35 °C
Φ_{LUM}	Flux (lm)	613lm
	Lifetime	(L70B50>) 40.000h
	CEE Energy classification	F

References



	W	ϕ	ϕ_{LUM}	K	\leftrightarrow
575034	6,5W	>0,5	613lm	3.000K	50x56mm

Dimensions



Photometry

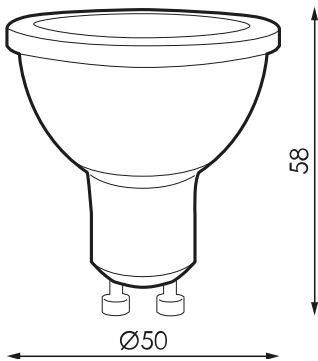

Accessories



974851

GU10/GZ10
LAMPHOLDER WITH
SILICONE CABLE